



HARDWARE REFERENCE MANUAL
VERSION: V1.0.1

JPK-1300

Jetpack 3x1 Switching, Transport, and Control Solution



UA Version



EK Version



AV FOR AN IT WORLD®

IMPORTANT SAFETY INSTRUCTIONS

1. READ these instructions.
2. KEEP these instructions.
3. HEED all warnings.
4. FOLLOW all instructions.
5. DO NOT use this apparatus near water.
6. CLEAN ONLY with dry cloth.
7. DO NOT block any ventilation openings. Install in accordance with the manufacturer's instructions.
8. DO NOT install near any heat sources such as radiators, heat registers, stoves, or other apparatus (including amplifiers) that produce heat.
9. DO NOT defeat the safety purpose of the polarized or grounding type plug. A polarized plug has two blades with one wider than the other. A grounding type plug has two blades and a third grounding prong. The wider blade or the third prong are provided for your safety. If the provided plug does not fit into your outlet, consult an electrician for replacement of the obsolete outlet.
10. PROTECT the power cord from being walked on or pinched, particularly at plugs, convenience receptacles, and the point where they exit from the apparatus.
11. ONLY USE attachments/accessories specified by the manufacturer.
12. USE ONLY with a cart, stand, tripod, bracket, or table specified by the manufacturer, or sold with the apparatus. When a cart is used, use caution when moving the cart/apparatus combination to avoid injury from tip-over.
13. UNPLUG this apparatus during lightning storms or when unused for long periods of time.
14. REFER all servicing to qualified service personnel. Servicing is required when the apparatus has been damaged in any way, such as power-supply cord or plug is damaged, liquid has been spilled or objects have fallen into the apparatus, the apparatus has been exposed to rain or moisture, does not operate normally, or has been dropped.
15. DO NOT expose this apparatus to dripping or splashing and ensure that no objects filled with liquids, such as vases, are placed on the apparatus.
16. To completely disconnect this apparatus from the AC Mains, disconnect the power supply cord plug from the AC receptacle.
17. Where the mains plug or an appliance coupler is used as the disconnect device, the disconnect device shall remain readily operable.
18. DO NOT overload wall outlets or extension cords beyond their rated capacity as this can cause electric shock or fire.
19. Please use the HDMI cable with magnetic ring.



The exclamation point, within an equilateral triangle, is intended to alert the user to the presence of important operating and maintenance (servicing) instructions in the literature accompanying the product.

The lightning flash with arrowhead symbol within an equilateral triangle is intended to alert the user to the presence of uninsulated "dangerous voltage" within the product's enclosure that may be of sufficient magnitude to constitute a risk of electrical shock to persons.

ESD Warning: The icon to the left indicates text regarding potential danger associated with the discharge of static electricity from an outside source (such as human hands) into an integrated circuit, often resulting in damage to the circuit.



WARNING: To reduce the risk of fire or electrical shock, do not expose this apparatus to rain or moisture.

WARNING: No naked flame sources - such as candles - should be placed on the product.

WARNING: Equipment shall be connected to a MAINS socket outlet with a protective earthing connection.

WARNING: To reduce the risk of electric shock, grounding of the center pin of this plug must be maintained.

COPYRIGHT NOTICE

AMX© 2023, all rights reserved. No part of this publication may be reproduced, stored in a retrieval system, or transmitted, in any form or by any means, electronic, mechanical, photocopying, recording, or otherwise, without the prior written permission of AMX. Copyright protection claimed extends to AMX hardware and software and includes all forms and matters copyrightable material and information now allowed by statutory or judicial law or herein after granted, including without limitation, material generated from the software programs which are displayed on the screen such as icons, screen display looks, etc. Reproduction or disassembly of embodied computer programs or algorithms is expressly prohibited.

LIABILITY NOTICE

No patent liability is assumed with respect to the use of information contained herein. While every precaution has been taken in the preparation of this publication, AMX assumes no responsibility for error or omissions. No liability is assumed for damages resulting from the use of the information contained herein. Further, this publication and features described herein are subject to change without notice.

AMX WARRANTY AND RETURN POLICY

The AMX Warranty and Return Policy and related documents can be viewed/downloaded at www.amx.com.

ESD WARNING



To avoid ESD (Electrostatic Discharge) damage to sensitive components, make sure you are properly grounded before touching any internal materials.

When working with any equipment manufactured with electronic devices, proper ESD grounding procedures must be followed to make sure people, products, and tools are as free of static charges as possible. Grounding straps, conductive smocks, and conductive work mats are specifically designed for this purpose. These items should not be manufactured locally, since they are generally composed of highly resistive conductive materials to safely drain static discharges, without increasing an electrocution risk in the event of an accident.

Anyone performing field maintenance on AMX equipment should use an appropriate ESD field service kit complete with at least a dissipative work mat with a ground cord and a UL listed adjustable wrist strap with another ground cord.



CAUTION

RISK OF ELECTRIC SHOCK
DO NOT OPEN



WARNING: Do Not Open! Risk of Electrical Shock. Voltages in this equipment are hazardous to life. No user-serviceable parts inside. Refer all servicing to qualified service personnel. Place the equipment near a main power supply outlet and make sure that you can easily access the power breaker switch.

WARNING: This product is intended to be operated ONLY from the voltages listed on the back panel or the recommended, or included, power supply of the product. Operation from other voltages other than those indicated may cause irreversible damage to the product and void the products warranty. The use of AC Plug Adapters is cautioned because it can allow the product to be plugged into voltages in which the product was not designed to operate. If the product is equipped with a detachable power cord, use only the type provided with your product or by your local distributor and/or retailer. If you are unsure of the correct operational voltage, please contact your local distributor and/or retailer.

FCC AND CANADA EMC COMPLIANCE INFORMATION:

This device complies with part 15 of the FCC Rules. Operation is subject to the following two conditions:

(1) This device may not cause harmful interference, and (2) this device must accept any interference received, including interference that may cause undesired operation.

NOTE: This equipment has been tested and found to comply with the limits for a Class A digital device, pursuant to part 15 of the FCC Rules. These limits are designed to provide reasonable protection against harmful interference in a commercial environment. This equipment generates, uses and can radiate radio frequency energy and, if not installed and used in accordance with the instructions, may cause harmful interference to radio communications. However, there is no guarantee that interference will not occur in a particular installation. If this equipment does cause harmful interference to radio or television reception, which can be determined by turning the equipment off and on, the user is encouraged to try to correct the interference by one or more of the following measures:

- Reorient or relocate the receiving antenna.
- Increase the separation between the equipment and receiver.
- Connect the equipment into an outlet on a circuit different from that to which the receiver is connected.
- Consult the dealer or an experienced radio/TV technician for help.

Approved under the verification provision of FCC Part 15 as a Class A Digital Device.

Caution

Changes or modifications not expressly approved by the manufacturer could void the user's authority to operate this device. CAN ICES-3 (B)/NMB-3(B)

EU COMPLIANCE INFORMATION:

Eligible to bear the CE mark; Conforms to European Union Low Voltage Directive 2006/95/EC; European Union EMC Directive 2004/108/EC; European Union Restriction of Hazardous Substances Recast (RoHS2) Directive 2011/65/EU; European Union WEEE (recast) Directive 2012/19/EU; European Union Radio and Telecommunications Terminal Equipment (R&TTE) Directive 1999/5/EC

WEEE NOTICE:



This appliance is labeled in accordance with European Directive 2012/19/EU concerning waste of electrical and electronic equipment (WEEE). This label indicates that this product should not be disposed of with household waste. It should be deposited at an appropriate facility to enable recovery and recycling.

Table of Contents

Important Safety Instructions	2
Overview	6
Features.....	6
Package Contents.....	6
Specifications	7
Keypad Description(UA Version)	9
Wall-plate Transmitter Panel Description(UA Version).....	10
Receiver Panel Description(UA Version).....	11
Pinout Information	12
RS232	12
RELAY	12
Audio Out.....	13
Installation and Connection.....	14
Basic Operations	16
Input Source Switching	17
Auto Switching.....	17
Manual Switching.....	17
PC Tool Control	18
Discover.....	18
Control	19
Schedule.....	20
Settings.....	21
Update	22
Device Online Tree.....	22
Web UI Control.....	23
Video	24
Audio.....	24
Control	25
Schedule.....	27
Network.....	28
System.....	29
Firmware Upgrade	31
Before Starting	31
Transferring KIT Files.....	31
Troubleshooting	33
API Command Set	34
System Commands.....	35
Network Commands	38
Security Commands	40
Video and Audio Commands (Direct Control)	41
Control Commands (Direct Control)	47
Schedule Commands (Direct Control).....	54

Overview

The JPK-1300 is designed for multi-function AV intelligent education system. It consists of a Keypad, a Wall-plate Transmitter and an All-in-one Receiver. It offers 2 HDMI and USB Type-C video extension, video switching and system control. Uncompressed video and audio can be transmitted up to 70m/230ft at 1080P or 40m/131ft at 4K2K@30 (YUV 4:4:4) over a shielded Cat 6/6A/7 cable. The product supports USB signal pass-through, RS-232 control, Relay, IR (IR pass-through & IR learning), audio de-embedding, USB-AUDIO, ARC function and CEC control. This design of HDBaseT™ technology allows for full usage of HDMI and controls over Cat 6/6A/7 cable. The product can be controlled through panel buttons, Web GUI and PC tool.

Keypad contains a volume knob (with MUTE function) and six control keys. It supports two HDMI and one USB-C input selection.

Wall-plate Transmitter contains one USB-C input (without charging function), two HDMI inputs, one USB-B input, an IR learning window and an input selection button.

Receiver supports MIC input, mixing and 2x25W 4/8 Ohms audio amplifier output, IR output, CEC control, Relay control, RS-232 control, MUTE control, HDMI and USB output.

The same hardware design can meet different specifications and market demands of US/EU/UK only by replacing the front panel of the Wall-plate (Video Panel).

Features

- HDMI 2.0 and HDCP 2.2 compliant
- Supports video resolution up to 4K2K@50/60Hz 4:2:0, 10.2Gbps video bandwidth
- HDMI audio formats: LPCM, Dolby Digital/Plus/EX, Dolby True HD, DTS, DTS-EX, DTS-96/24, DTS High Res, DTS-HD MA, DSD
- Supports HDR, Dolby Vision and HLG
- HDBT transmits lossless and zero-delay video & audio up to 230ft/70m for 1080P or 131ft/40m for 4K via a Shielded Cat 6/6A/7 cable
- Supports audio de-embedding and ARC function (the audio will be output through the Linear audio output port)
- Supports IR pass-through, RS-232 control and CEC control
- Supports controlling the external devices through IR/CEC/RS-232
- Supports unbalanced and balanced MIC inputs
- Supports mono unbalanced and balanced LINE inputs
- One-way 24V PoC function (Receiver → Wall-plate → Keypad)
- Wall-plate Transmitter supports IR learning
- USB-C port supports DP Alt Mode for audio and video transmission
- USB-C port supports USB 2.0 sound card, which can independently transmit audio to the Receiver
- Control via panel buttons, RS-232, TCP/IP, REST API, Web GUI and PC tool

Package Contents (UA Version)

- 1 x JPK-1300 Wall-plate Transmitter (with Screws)
- 1 x JPK-1300 Keypad (with Screws)
- 1 x JPK-1300 Receiver
- 1 x Phoenix Connector (3.81mm, 2 Pins)
- 4 x Phoenix Connector (3.81mm, 3 Pins)
- 1 x Phoenix Connector (5.08mm, 4 Pins)
- 1 x IR Wideband Emitter Cable (1.5 meters)
- 2 x Mounting Bracket (with Screws)
- 1 x DC 24V/3.75A Power Adapter
- 2 x Power Cord (IEC Type B & IEC Type I for UA version)
- 1 x Quick Start Guide

Package Contents (EK Version)

- 1 x JPK-1300 Wall-plate Transmitter (with Screws)
- 1 x JPK-1300 Keypad (with Screws)
- 1 x JPK-1300 Receiver
- 1 x Phoenix Connector (3.81mm, 2 Pins)
- 4 x Phoenix Connector (3.81mm, 3 Pins)
- 1 x Phoenix Connector (5.08mm, 4 Pins)
- 1 x IR Wideband Emitter Cable (1.5 meters)
- 2 x Mounting Bracket (with Screws)
- 1 x DC 24V/3.75A Power Adapter
- 2 x Power Cord (IEC Type G and IEC Type E/F (CEE 7/7 Plug) for EK version)
- 1 x Quick Start Guide

Specifications

Technical	
HDMI Compliance	HDMI 2.0
HDCP Compliance	HDCP 2.2
Video Bandwidth	297MHz/10.2Gbps
Video Network Bandwidth	10G
Video Resolution	480i ~1080p50/60Hz, 4Kx2K@24/30Hz, 4k2k@50Hz/60Hz 4:2:0
Color Depth	8/10/12-bit (1080P60Hz) 8-bit (4K30Hz 4:4:4)
Color Space	RGB, YCbCr 4:4:4 / 4:2:2. YUV 4:2:0
HDR	HDR, Dolby Vision, HLG
IR Level	12Vp-p
IR Frequency	Wideband 20 k - 60 KHZ
Audio Formats	<ul style="list-style-type: none"> HDMI: LPCM, Dolby Digital/Plus/EX, Dolby True HD, DTS, DTS-ES,DTS-96/24, DTS High Res, DTS-HD MA, DSD Linear audio out: PCM 2.0
Control Method	<ul style="list-style-type: none"> Front panel buttons PC tool Web UI RS-232 control (API Commands)
PC Requirements	<ul style="list-style-type: none"> Memory: 8GB Graphic: Intel HD graphics 4000 or above OS Compatibility: Windows 7 (64-bit), Windows 10, Windows 11 Mac OS 10.12 or newer Storage: >= 300MB
Connections	
Keypad	INPUT: 1 × CONTROL (RJ45) 1 × MICRO USB (Update port)
Wall-plate Transmitter	INPUT: 2 × HDMI IN (Type A, 19-pin port) 1 × USB-C IN (24-pin port) 1 × USB HOST (USB Type B) 1 × IR Receive Window 1 × MICRO USB (Update port) OUTPUT: 1 × AV LINK (RJ45) 1 × CONTROL (RJ45)
Receiver	INPUT: 1 × AV LINK (RJ45) 1 × LAN 10/100 (RJ45) 1 × REMOTE MUTE (2pin-3.81mm Phoenix Connector) 1 × MIC/LINE IN (3pin-3.81mm Phoenix Connector) 1 × DC 24V 1 × MICRO USB (Update port) OUTPUT: 1 × HDMI OUT (Type A, 19-pin port) 1 × IR OUT (3.5mm Stereo Mini-jack) 1 × USB DEVICE (USB Type A) 1 × RS-232 (3pin-3.81mm Phoenix Connector) 1 × RELAY (3pin-3.81mm Phoenix Connector) 1 × AUDIO OUT(3pin-3.81mm Phoenix Connector) 1 × AMP OUT (4pin-5.08mm Phoenix Connector)

Specifications

General	
Operating Temperature	0°C to 40°C (32°F to 104°F)
Storage Temperature	-20°C to 60°C (-4°F to 140°F)
Humidity	20% to 90%, non-condensing
ESD Protection	Human-body Model: ±8kV (Air-gap discharge)/±4kV (Contact discharge)
Power Supply	Input: AC100 - 240V 50/60Hz Output: DC 24V/3.75A (US/EU standards, CE/FCC/UL certified)
Power Consumption (Max)	80W (TX + RX + Keypad)
Device Dimension (W x H x D)	UA Version: <ul style="list-style-type: none"> Keypad: Front panel: 70mm x 114mm x 22.2mm / 2.76" x 4.49" x 0.87" Rear case: 69.4mm x 48.4mm x 17.2mm / 2.73" x 1.91" x 0.68" Wall-plate Transmitter: Front panel: 116mm x 114mm x 39.2mm / 4.57" x 4.49" x 1.54" Rear case: 85.8mm x 52.6mm x 34.2mm / 3.38" x 2.07" x 1.35" Receiver: 250mm x 30mm x 104mm / 9.84" x 1.18" x 4.09" EK Version: <ul style="list-style-type: none"> Keypad: Front panel: 146mm x 85mm x 22.2mm / 5.75" x 3.35" x 0.87" Rear case: 69.4mm x 48.4mm x 17.2mm / 2.73" x 1.91" x 0.68" Wall-plate Transmitter: Front panel: 146mm x 85mm x 39.2mm / 5.75" x 3.35" x 1.54" Rear case: 85.8mm x 52.6mm x 34.2mm / 3.38" x 2.07" x 1.35" Receiver: 250mm x 30mm x 104mm / 9.84" x 1.18" x 4.09"
Product Weight	UA Version: <ul style="list-style-type: none"> Keypad: 0.19kg/0.42lb Wall-plate Transmitter: 0.35kg/0.77lb Receiver: 0.81kg/1.79lb EK Version: <ul style="list-style-type: none"> Keypad: 0.23kg/0.51lb Wall-plate Transmitter: 0.33kg/0.73lb Receiver: 0.81kg/1.79lb
Certification	CE, FCC, ETL, PSE, RCM

Transmission Distance

Note: Straight-through category cable wired to T568B standard is recommended.

Cable Type	Range	Supported Video
Shielded Cat 6/6A/7	70m/230ft	1080P
	40m/131ft	4K2K@30 (YUV 4:4:4)
HDMI	Input: 12m/39ft Output: 12m/39ft	1080P@60Hz
	Input: 10m/33ft Output: 10m/33ft	4K@60Hz 4:2:0
USB	Input: 1.5m/4.9ft	4K@60Hz 4:2:0

Keypad Description (UA Version)

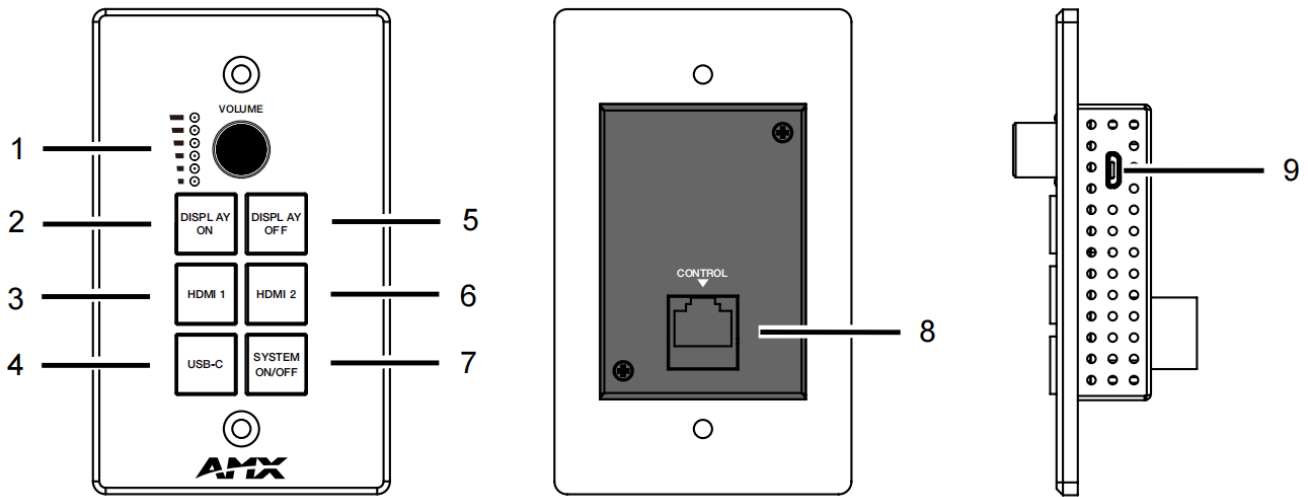

No.	Name	Description
1	Volume Knob and Volume Level Indicator	Use the volume knob to adjust the audio output volume of the amplifier, the corresponding volume level indicator will be on. <ul style="list-style-type: none"> Rotating clockwise will increase the audio volume; Rotating counterclockwise will decrease the audio volume.
2	DISPLAY ON Button	Press this button to turn on display devices. For details, please refer to the System Control setting instructions in the Control page of Web UI Control.
3	HDMI 1 Button	Press this button to select the HDMI IN 1 port of TX as the signal input channel.
4	USB-C Button	Press this button to select the USB-C port of TX as the signal input channel.
5	DISPLAY OFF Button	Press this button to turn off display devices. For details, please refer to the System Control setting instructions in the Control page of Web UI Control.
6	HDMI 2 Button	Press this button to select the HDMI IN 2 port of TX as the signal input channel.
7	SYSTEM ON/OFF Button	Press and hold this button for three seconds to turn on/off the system.
8	CONTROL port	Connect to the CONTROL port of TX via a Cat 6/6A/7 cable.
9	MICRO USB port	Used for Software upgrade.

Wall-plate Transmitter Panel Description (UA Version)

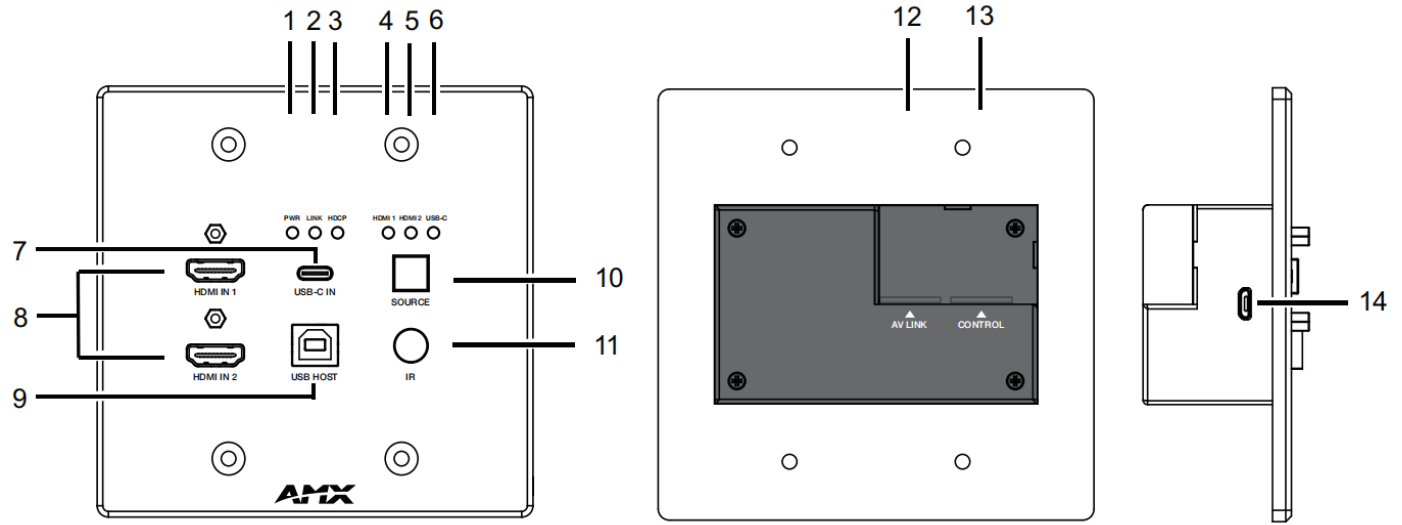

No.	Name	Description
1	POWER LED (Green)	On: JPK-1300 TX is powered on. Off: JPK-1300 TX is powered off or in standby.
2	LINK LED (Green)	LED indicates the connection status of the TX and RX. On: JPK-1300 TX and RX are linked. Blinking: Link error. Off: No link.
3	HDCP LED (Green)	On: Signal is being transmitted with HDCP. Off: Signal is being transmitted without HDCP or no signal is being transmitted.
4	HDMI 1 LED (Green)	On: The HDMI IN 1 port is selected as the signal input channel. Off: The HDMI IN 1 port is not selected as the signal input channel.
5	HDMI 2 LED (Green)	On: The HDMI IN 2 port is selected as the signal input channel. Off: The HDMI IN 2 port is not selected as the signal input channel.
6	USB-C LED (Green)	On: The USB-C port is selected as the signal input channel. Off: The USB-C port is not selected as the signal input channel.
7	USB-C IN Port	USB-C signal input port. Connect to the USB-C source device (such as PC) with USB-C cable.
8	HDMI IN 1/2 Port	HDMI signal input port. Connect to the HDMI source device (such as DVD player or PC) with HDMI cable.
9	USB HOST	Connect to the PC or Notebook with USB cable.
10	SOURCE Button	Press this button to circularly select the signal input channel, and the corresponding HDMI 1/HDMI 2/ USB-C LED will be on.
11	IR Window	Used for IR pass-through or IR learning.
12	AV LINK Port	HDBaseT output port. Connect to the AV LINK port of RX with Cat 6/6A/7 cable.
13	CONTROL Port	Connect to the CONTROL port of Keypad with Cat 6/6A/7 cable.
14	MICRO USB Port	Used for Software upgrade.

Receiver Panel Description (UA Version)

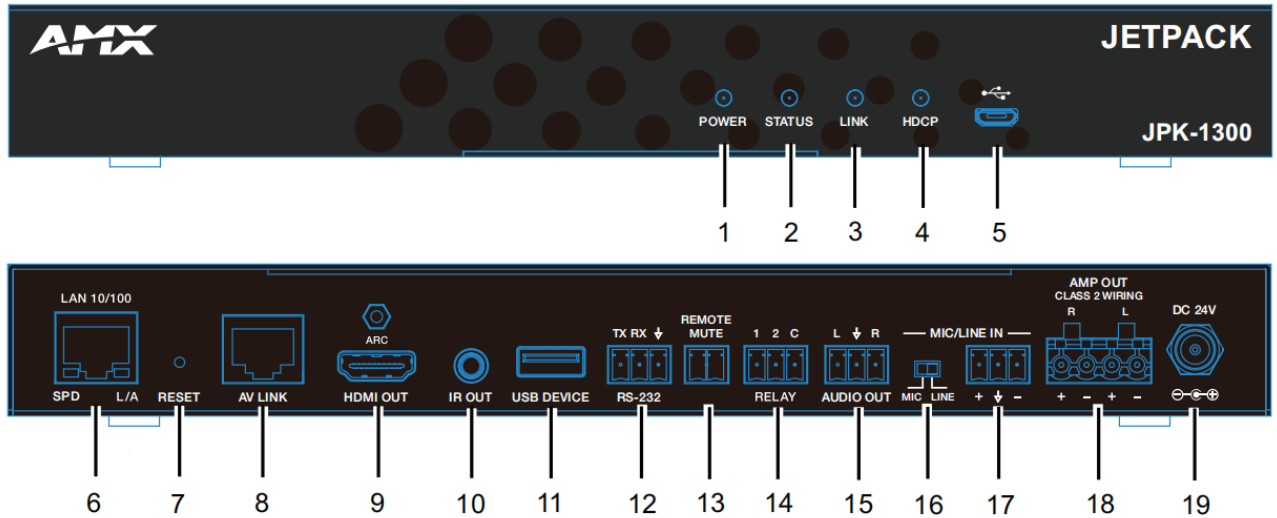

No.	Name	Description
1	POWER LED (Green)	On: JPK-1300 RX is powered on. Off: JPK-1300 RX is powered off or in standby.
2	STATUS LED (Green)	On: JPK-1300 RX is working properly. Blinking: JPK-1300 RX is not working properly.
3	LINK LED (Green)	LED indicates the connection status of the TX and RX. On: JPK-1300 TX and RX are linked. Blinking: Link error. Off: No link.
4	HDCP LED (Green)	On: Signal is being transmitted with HDCP. Off: Signal is being transmitted without HDCP or no signal is being transmitted.
5	MICRO USB Port	Used for Software upgrade.
6	LAN 10/100	Connect to PC for Web UI control.
7	RESET	When JPK-1300 RX is powered on, use a pointed stylus to hold down the RESET button for five seconds, and then release it, it will reboot and restore to its factory defaults.
8	AV LINK Port	HDBaseT input port. Connect to the AV LINK port of TX with Cat 6/6A/7 cable.
9	HDMI OUT Port	HDMI signal output port. Connect to the HDMI display device (such as TV or Projector).
10	IR OUT Port	IR signal output port. Connect with IR Blaster cable.
11	USB DEVICE Port	USB Type A port. Connect to USB devices such as electronic whiteboard, USB camera, mouse or keyboard.
12	RS-232 Port	RS-232 control port. Used to control devices with RS-232 port, such as Projector.
13	REMOTE MUTE Port	Fire alarm trigger port. Used to mute the audio output function when there is a fire.
14	RELAY Port	RELAY control port. Used to control projection screen rise and fall.
15	AUDIO OUT Port	Linear audio output port. Connect to amplifier or other audio LINE IN input devices.
16	MIC/LINE Selection Switch	When selecting "MIC" with the switch, connect the MIC/LINE IN port to a dynamic microphone; When selecting "LINE" with the switch, connect the MIC/LINE IN port to a wire-level audio source or wireless microphone. There are two connection methods: 1. Unbalanced connection: Connect "+" to MIC signal, and connect "⊥" to the ground. 2. Balanced connection: Connect "+" to the positive signal of the microphone balance, and connect "-" to the negative signal of the microphone balance.
17	MIC/LINE IN port	Connect a dynamic microphone or a wireless microphone compatible with linear audio.
18	AMP OUT Port	4pin Phoenix Connector. Connect to speakers for audio mixing output.
19	DC 24V Port	DC 24V power input port.

Pinout Information

The following figures show the pinouts of the Phoenix Connectors.

RS232

Connects to an RS232-enabled device with the 3-pole, 3.81mm captive screw connectors. Wire as shown below:

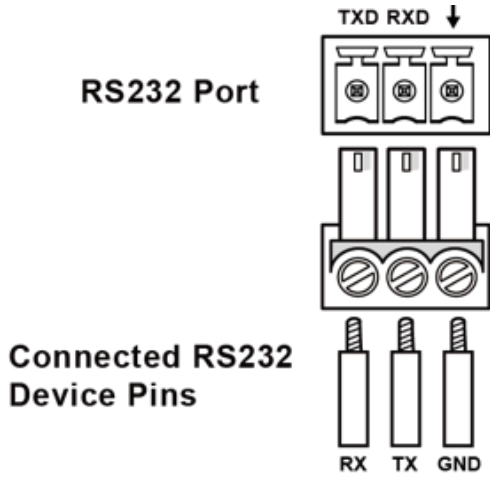

RELAY

Connects to a projector screen with the 3-pole, 3.81mm captive screw connectors. Wire as shown below:

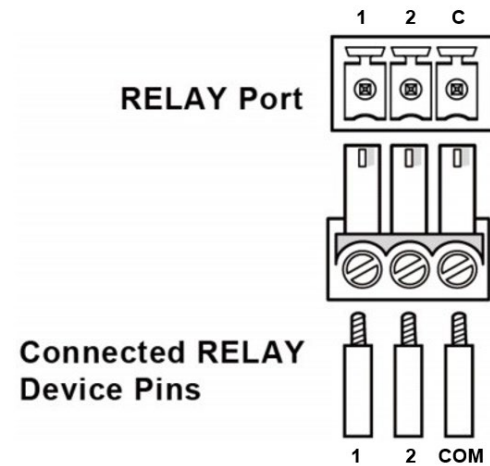

Audio Out

Connect to an audio device with the 3-pole, 3.81mm captive screw connector. Wire as shown below:

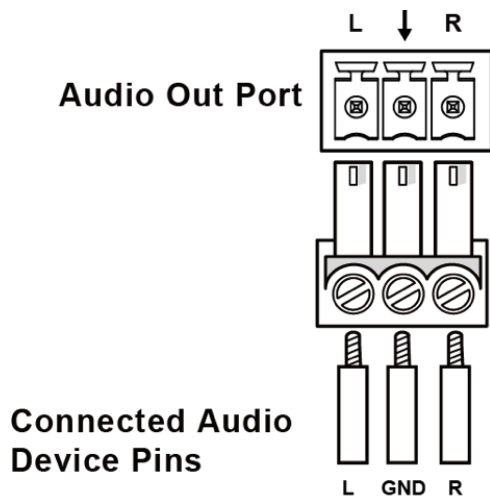

Installation and Connection

Cable Requirements

1. CONTROL port connection distance is up to 164ft/50m via a Shielded Cat 6/6A/7 cable. The CONTROL cable must be pre-run from the Wall-plate Transmitter backbox to the Keypad backbox.
2. AV LINK port connection distance is up to 230ft/70m for 1080P video or 131ft/40m for 4K video via a Shielded Cat 6/6A/7 cable. The AV LINK cable must be pre-run from the Receiver installation location to the Wall-plate Transmitter backbox.

Install Jetpack Receiver

1. Position and install the mounting brackets of JPK-1300 RX with the 4 mounting screws provided, as shown below.

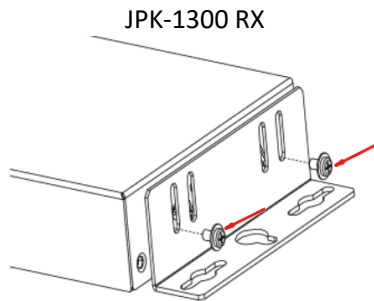

2. Mount and secure the JPK-1300 to a surface or a suitable location using appropriate mounting screws.

Connect Jetpack Receiver

1. Connect the pre-run AV LINK cable to the AV LINK port on the JPK-1300 RX.
2. Connect the power adapter provided to the JPK-1300 RX.
3. Connect HDMI OUT
Connect an HDMI display device (such as a projector) to the HDMI OUT port of the JPK-1300 RX.
4. Connect USB DEVICE
Connect a USB device (such as a Smart Board) to the USB DEVICE port of the JPK-1300 RX.
5. Connect MICROPHONE or OTHER ROOM AUDIO SOURCE
Connect an audio source (such as a microphone) to the MIC/LINE IN port of the JPK-1300 RX. (Make sure the MIC/LINE switch is turned to MIC when connecting a microphone to the MIC/LINE IN port.).
6. Connect AUDIO OUT
Connect the AUDIO OUT port to an amplifier or powered speakers and/or connect the AMP OUT port to 4/8 Ohm speakers using appropriate speaker cables.
7. Connections for additional control options:
 - LAN control (Web UI/PC tool/Telnet/SSH): Connect the JPK-1300 RX to the same network of the PC or control system via the LAN.
 - RS-232/IR/RELAY control: Connect the RS-232 or IR OUT port of the JPK-1300 RX to the display device such as a projector via an RS-232 cable or the IR emitter cable provided, and connect the RELAY port (1-2) to the electric lifting projection screen.
 - Remote mute control: Connect the REMOTE MUTE port of the JPK-1300 RX to the contact closure of the fire alarm system.

Note: Please refer to the Instruction manual for the configuration of RS-232/IR/RELAY control and the REMOTE MUTE.

Connect Jetpack Devices

1. Connect one end of the pre-run CONTROL cable to the CONTROL port on the JPK-1300 Wall-plate TX and the other end to the CONTROL port on the JPK-1300 keypad.
2. Connect the free end of the pre-run AV LINK cable to the AV LINK port on the JPK-1300 Wall-plate TX.

Installing Jetpack Wall-plate Transmitter and Keypad

To install the UA version JPK-1300 Wall-plate TX and Keypad:

1. Place the wall-plate TX and keypad into US standard back box.
2. Secure the wall-plate TX and keypad with the white screws provided, as shown below.

JPK-1300-UA TX

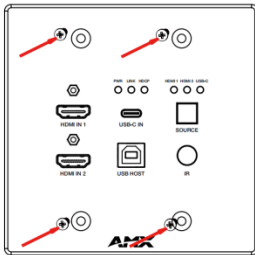

JPK-1300-UA Keypad

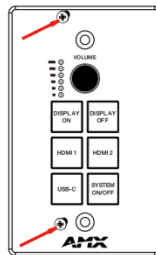

To install the EK version JPK-1300 Wall-plate TX and Keypad:

1. Remove the white screws on the cover of the wall-plate TX and keypad and remove the cover.
2. Place the wall-plate TX and keypad into an EU standard back box, and secure with the screws provided, as shown below.

JPK-1300-EK TX

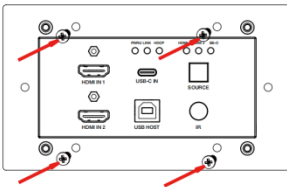

JPK-1300-EK Keypad

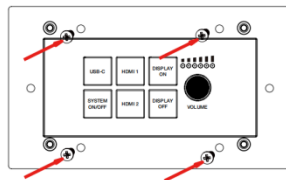

Note: Use the two screw holes on the left and right ends to install the EK version wall-plate TX and keypad into UK standard back boxes.

3. Secure the cover back to the wall-plate TX and keypad with the white screws provided, as shown below.

JPK-1300-EK TX

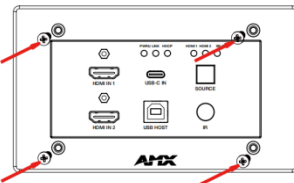

JPK-1300-EK Keypad

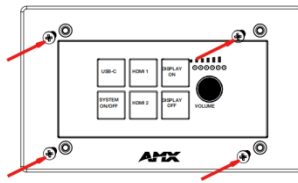

Connecting Jetpack TX to Source Equipment

1. Connect HDMI / USB-C IN
Connect the HDMI and/or USB-C video sources to the HDMI IN 1, 2, or USB-C port of the JPK-1300 TX.
2. Connect USB HOST
If using an HDMI input, connect the USB HOST port on the JPK-1300 TX wall-plate to the USB port of the PC.

Basic Operations

1. Power on all the attached devices: When all are powered on, check all LED indicators on the JPK-1300 TX and RX to ensure the installation is successful.
2. Use the SYSTEM ON/OFF button on the JPK-1300 Keypad to turn on/off the system.
 - When the system is off, press to turn on the system.
 - When the system is on, press and hold for 3 seconds to turn off the system.
3. When the system is on, press DISPLAY ON or DISPLAY OFF button on the JPK-1300 Keypad to turn the display device on or off by RS-232/IR/CEC and raise or lower the projection screen by relays.
4. When the system is on, press the HDMI IN 1, HDMI IN 2, or USB-C buttons on the JPK-1300 Keypad or the SOURCE button on the JPK-1300 TX to switch the video source. Press and hold the currently selected video source button for three seconds to mute the video output, press again to unmute. Check the video output on the display device.
5. Connect MICROPHONE or OTHER ROOM AUDIO SOURCE to MIC/LINE IN port
 - Set MIC/LINE select switch to appropriate setting for the connected source.
6. Connect AMP OUT port to 4/8 Ohm speakers using appropriate speaker cables.
 - The correct speaker impedance loading must be observed. By default, the amplifier is configured for use with 8 Ohm speakers. The Web UI or Telnet/SSH commands can be used to configure the amplifier for 4 Ohm loads if 4 Ohm speakers are required.
7. When the system is on, turn the knob on the JPK-1300 Keypad to adjust the volume, or press the knob to mute and unmute the volume.

Typical Connection Diagram

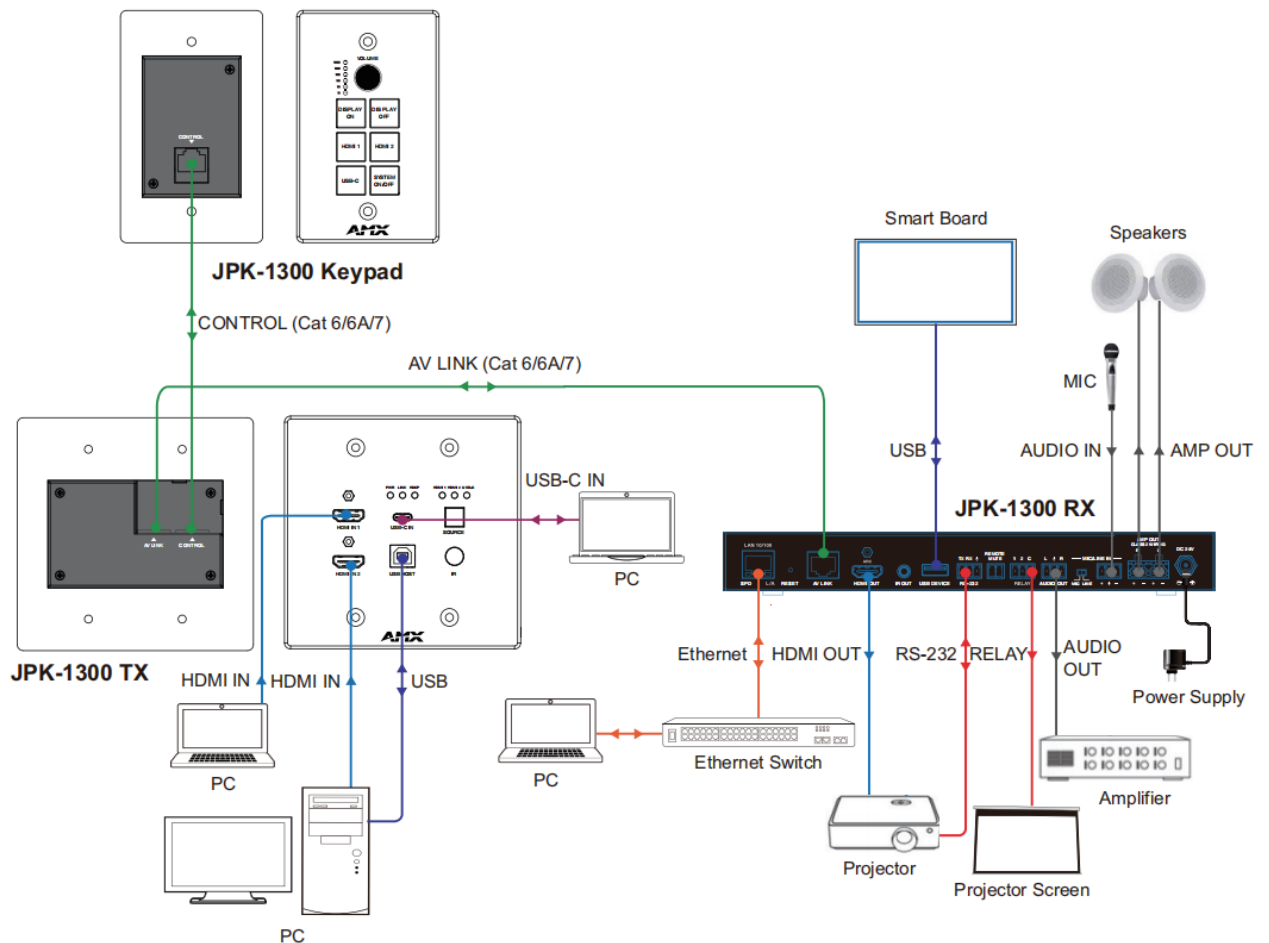

Input Source Switching

The JPK-1300 Kit supports Auto and Manual Switching between the HDMI and USB-C inputs.

Auto Switching

1. When multiple sources are inserted, and power is ON for all devices, the input will be switched to the last selected input port of the last operation.
2. When a new source is inserted, the input will be switched to it automatically, following the Last-In-First-Out rule.
3. When the currently selected source is removed, the input will first be switched to the most recently selected port.

Note:

- The Auto Switching function is enabled by default once all devices are powered on.
- Auto Switching can be set to Enabled or Disabled through PC tool and Web UI control.

Manual Switching

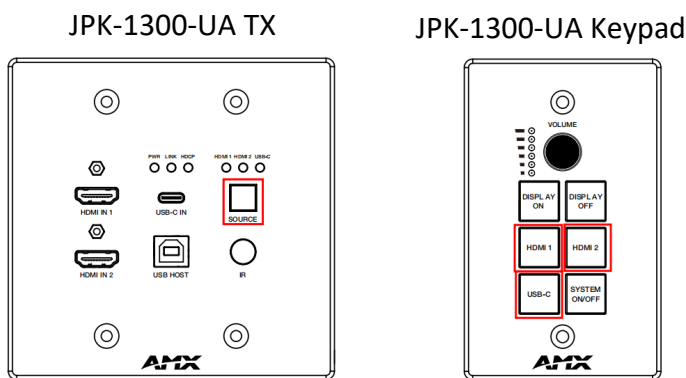

The JPK-1300 Kit supports Manual Switching between the HDMI and USB-C inputs in four methods.

Method 1: Through the JPK-1300 Keypad

Press the HDMI 1/HDMI 2/USB-C button on the JPK-1300 Keypad to directly select the HDMI 1/HDMI 2/USB-C input source. Method 2:

Through the SOURCE button of JPK-1300 TX

Press the SOURCE button on the front panel of JPK-1300 TX to circularly select the HDMI 1/HDMI 2/USB-C input source.

Method 3: Through the PC tool control

For details, please refer to the Control setting of "PC Tool Control".

Method 4: Through the Web UI control

For details, please refer to the Video Switching operation in the Video setting of "Web UI Control".

Note:

- The Manual Switching function is enabled by default once all devices are powered on.
- Auto and Manual Switching functions exist simultaneously.

PC Tool Control

Controlling the JPK-1300 through the PC tool.

Download the “AMX Jetpack Manager” from amx.com and install this application tool on the PC. Before launching this tool, connect all the JPK-1300 kits and the PC into the same network.

The default IP mode of JPK-1300 is DHCP. If there is no DHCP server in the network, the default IP of JPK-1300 is 192.168.1.2. The IP addresses of all the kits in the same network can be discovered by the PC tool.

Launch AMX Jetpack Manager and select “DISCOVER” in the menu on the top.

Discover

The Discover page is used to discover devices and set device PIN code.

The PIN code is a string of 8 digits. (The default PIN code is 00000000.)

New PIN code can be applied on each device. To discover devices with multiple PIN codes, please separate multiple PIN codes with spaces (for example: 00000000 00000001 00000002...).

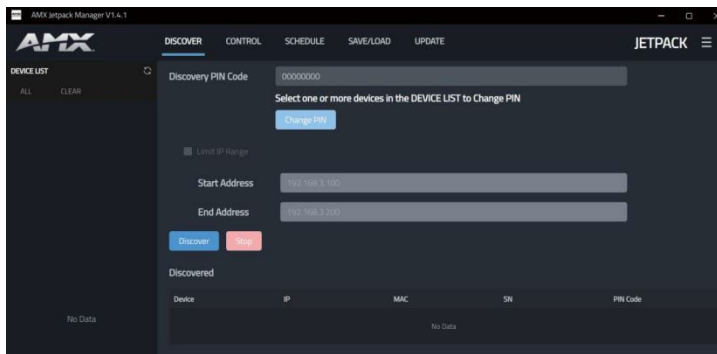

1. Discovering devices

There are two methods to discover devices:

Method 1: Auto Discover

Click DISCOVER, and then enter the PIN code in the Discovery PIN Code box, click the “Discover” button to start searching for devices. The discovered devices will be displayed in the Discovered list and shown in the DEVICE LIST. Finally, click the “Stop” button to stop searching.

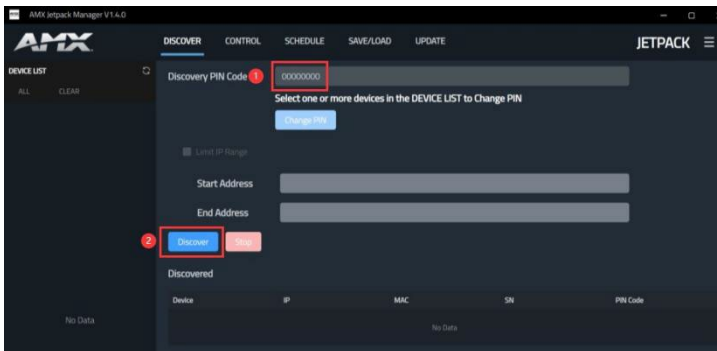

Method 2: Discover by IP

Enter the PIN code in the Discovery PIN Code box, select “Limit IP Range” and enter the IP address range with “Start Address” and “End Address”. Click the “Discover” button to start searching. The discovered devices will be displayed in the Discovered list and shown in the DEVICE LIST. Finally, click the “Stop” button to stop searching.

Note: “Start Address” and “End Address” must be in the same Network segment. (The subnet mask is 255.255.255.0.)

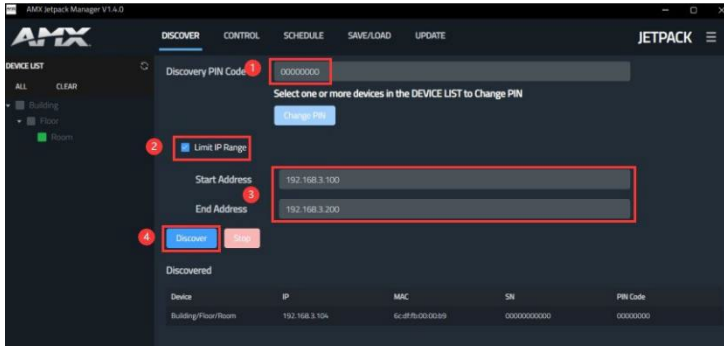

2. Set device PIN code in batches

Click the checkbox at the DEVICE LIST to select at least one device, for which the PIN code is to be set. Then click “Change PIN” to pop up the “Change PIN” window, as shown in the figure below. Enter an 8-digit PIN code in “New PIN Code”. Finally click “Set New PIN Code” to complete setting, and click “Done” to close the window.

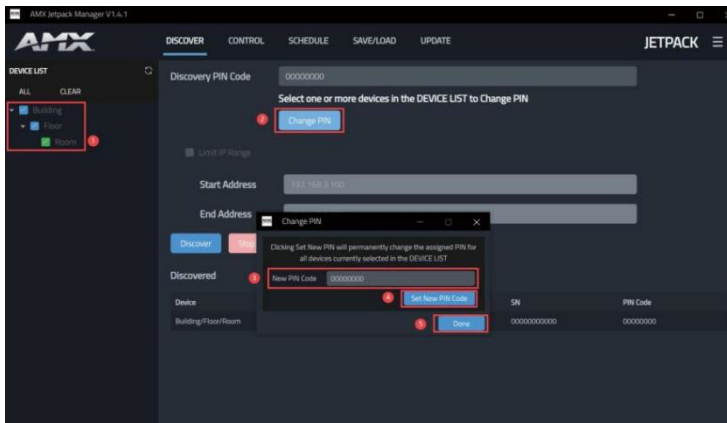

Control

1. Control devices

Click the device to be set at the DEVICE LIST, and the background of the selected device will turn gray. The information and Schedule list of the current device will be displayed. Then click the corresponding function on the right to set the Auto Switching, Volume, Audio Mute, Source Inputs, Microphone/Line Gain, Display, System function.

2. Web Console

Click the icon in the upper right corner to open the Preference window. Enter the Username and Password in Device Auto-login. Finally click Web Console to open the Web of the current selected device.

Note: Make sure that the password can pass verification no matter how you set the Username and Password, otherwise, it will not login automatically.

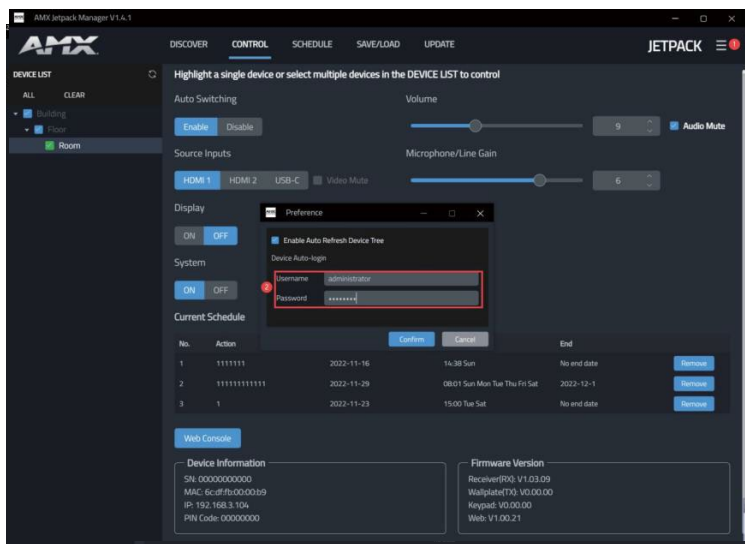

Schedule

1. Get device Schedule information

Click the checkbox to select the device at the DEVICE LIST, the corresponding Schedule information will be displayed on the right.

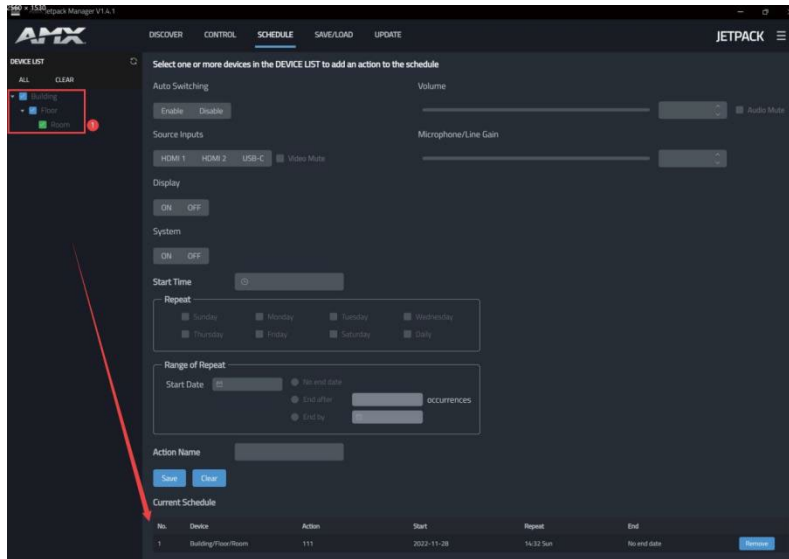

2. Add Schedule in batches

Please follow the steps below to add Schedule in batches:

Step 1, Click the checkbox at the DEVICE LIST to select the device.

Step 2, Click to set Auto Switching, Volume, Audio Mute, Source Inputs, Microphone/Line Gain, Display and System. Please note that the value of Volume and Microphone/Line Gain must be larger then 0.

Step 3, Set the repeat start time in "Start Time".

Step 4, Click to select the repeat mode. Please note that you must select at least one day when you select Weekly.

Step 5, Set the start date in "Range of Repeat".

Step 6, Set the end date in "Range of Repeat".

Step 7, Enter the "Action Name".

Step 8, Click "Save" to complete adding.

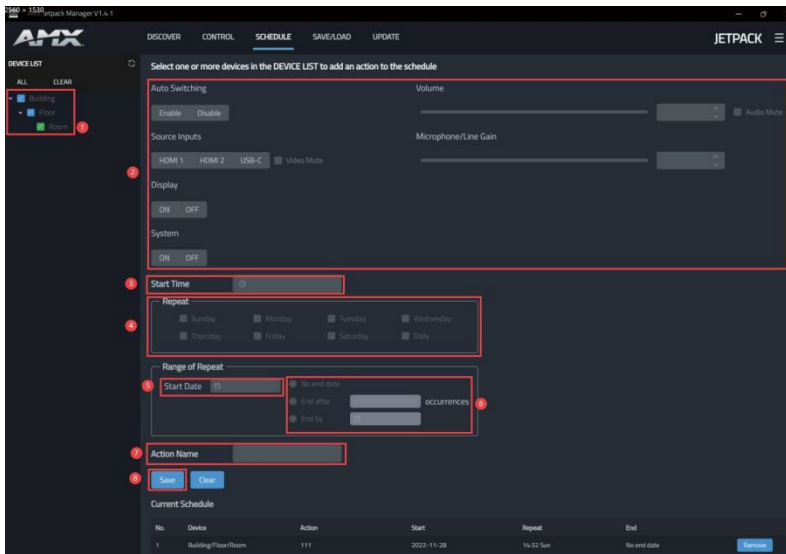

3. Remove Schedule

Click the “Remove” button in the Current Schedule list, and then click “Yes” to complete remove.

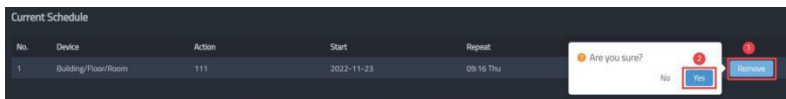

Settings

1. Export Configuration Files

Click the checkbox at the DEVICE LIST to select the device. Please note that, you can only choose one device at one time. Then click “Save Config”, select the file path, and click “Confirm” to save the file and complete exporting.

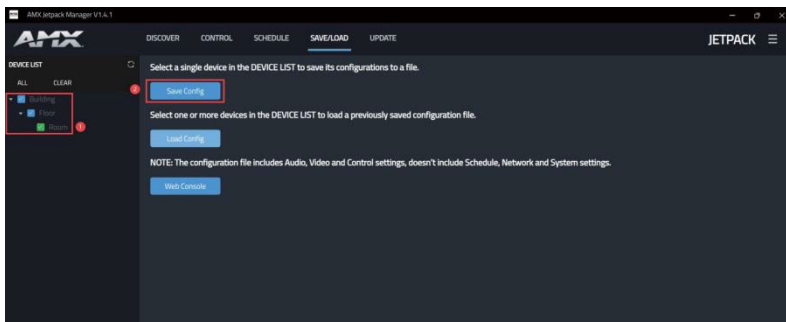

2. Import Configuration Files in batches

Click the checkbox at the DEVICE LIST to select at least one device, then click “Load Config” to select the configuration file to be imported. Finally, click “Confirm” to complete batch importing.

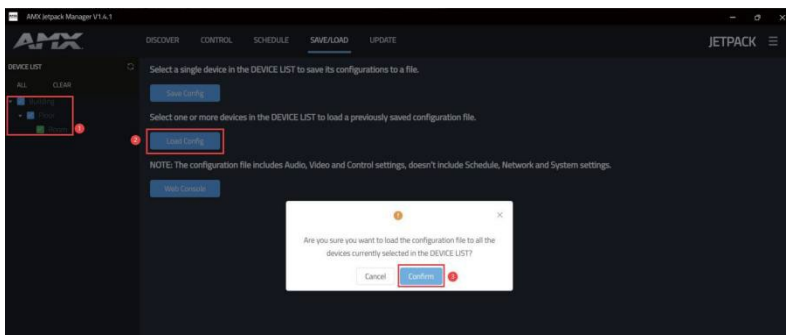

Update

1. Update devices in batches

Click the checkbox at the DEVICE LIST to select devices. Then click “Select Firmware File” to select the files to be updated, and click “Update All” to start batch updating.

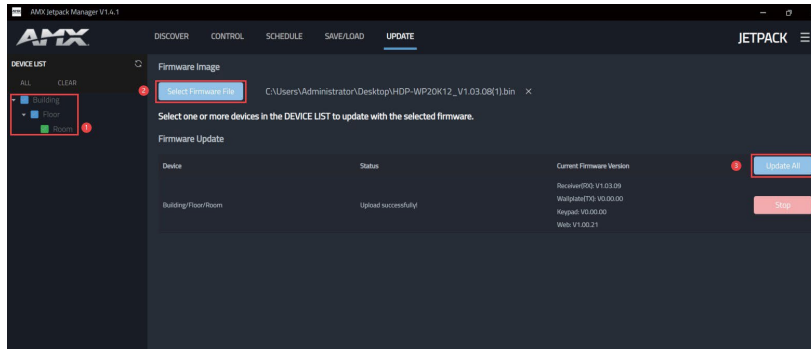

2. Update stages

The update is divided into several stages:

Stage 1. Upload the update file to the device. (In this state, clicking Stop on the right can stop the upgrade.)

Stage 2. Start to update.

Stage 3. Updating.

Stage 4. Update is complete or failed. At this time, the system displays the number of devices that have been successfully updated or failed to be updated.

Note: When updating a duplicate version, it will prompt that the upgrade cannot be repeated.

Device List

1. Device Status Description

The color of device at the DEVICE LIST indicates the status of the device as following. Green: The device is online and powered on.

Orange: The device is online but powered off.

Red: The device has been added into the system before, but it can not be detected during searching.

2. Remove devices

Right click the device at the DEVICE LIST, select “Delete Device”, click “Confirm” in the pop-up window to remove the device and its junior rank.

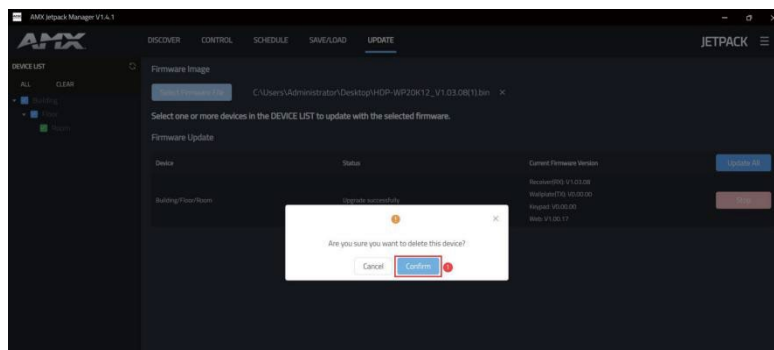
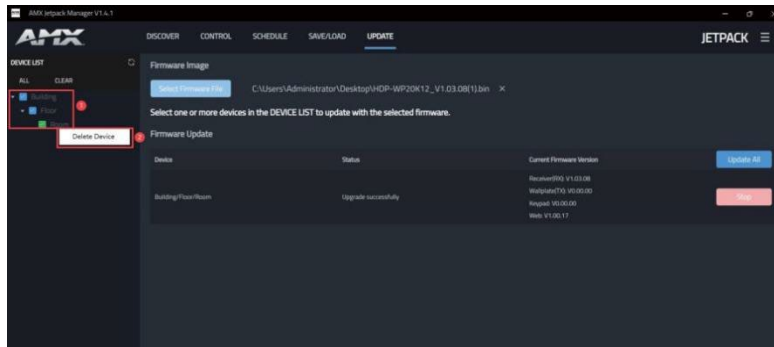

Web UI Control

The Web UI designed for the JPK-1300 allows basic controls and advanced settings of the device. To access the JPK-1300 Web UI:

1. Connect your PC and the LAN port of the JPK-1300 RX to the same local area network (without router).
2. Input the default IP address (192.168.1.2) of the JPK-1300 kit into your browser on the PC to enter Web UI. The following page will pop up. Enter the default Username “user” and the password “password”, then click “Login” to enter the User Web UI. The User Web UI displays as follows.

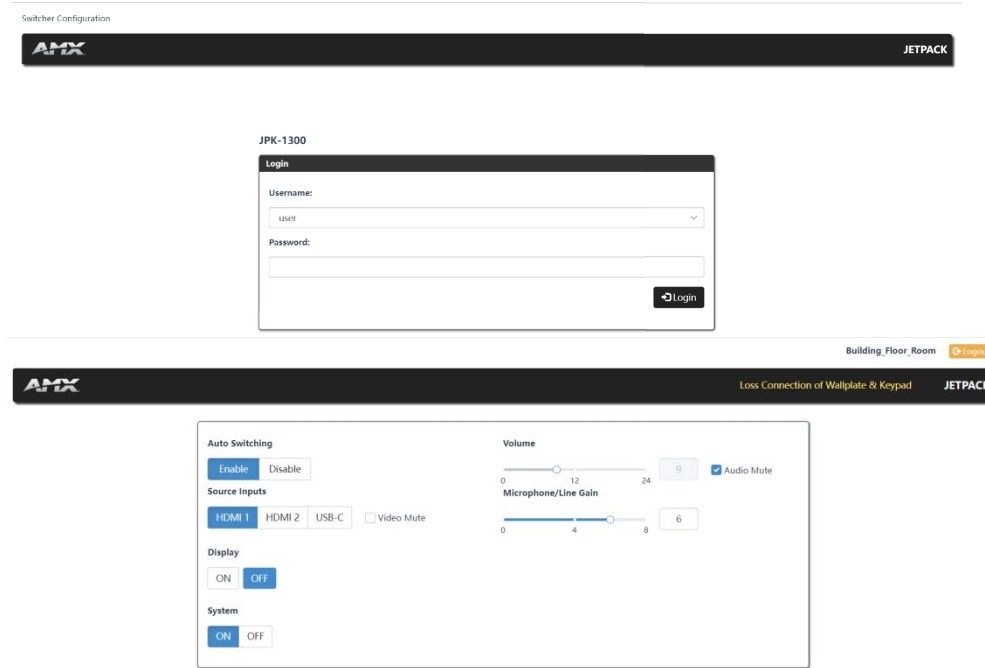

- (1) Logout: Click to logout from the Web UI.
 - (2) Auto Switching: Click to enable/disable the Auto Switching mode.
 - (3) Source Inputs: Click to select the HDMI 1/HDMI 2/USB-C input signal source. Check “Video Mute” to close HDMI output, and the corresponding input channel LED on the front panel of JPK-1300 TX and Keypad will not be on.
 - (4) Volume: Move the slider to adjust the output audio volume of the AMP OUT and AUDIO OUT port on JPK-1300 RX. Check “Audio Mute” to mute audio output.
 - (5) Microphone/Line Gain: Move the slider to adjust the output audio volume of the MIC/LINE IN port on JPK-1300 RX.
 - (6) Display: Click to power on/off display devices. (For details, please refer to the Control Settings on the Administrator Web UI.)
 - (7) System: Click to turn on/off the system.
3. On the Login page, enter the default Username “administrator” and the password “password”, then click “Login” to enter the Administrator Web UI.



The Administrator Web UI page consists of six sections: Video, Audio, Control, Schedule, Network, System.

Video

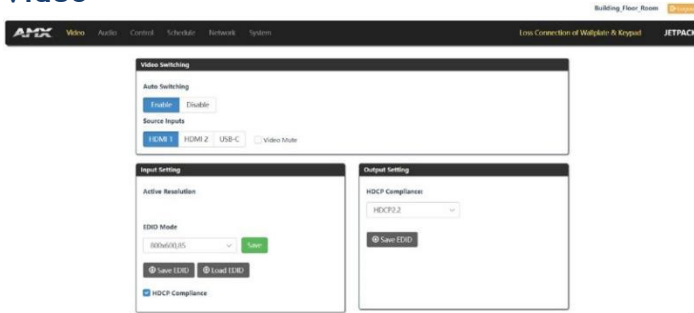

1. Video Switching:

- (1) Auto Switching: Click to enable/disable the Auto Switching mode.
- (2) Source Inputs: Click to select the HDMI 1/HDMI 2/USB-C input signal source. Check “Video Mute” to close HDMI output, and the corresponding input channel LED on the front panel of JPK-1300 TX and Keypad will not be on.

2. Input Setting:

- (1) Active Resolution: Display the resolution of the current video output.
- (2) EDID Mode: Click the drop-down menu to select the EDID

Mode. The EDID list is as follows:

Auto, Custom, 800x600_60, 800x600_72, 800x600_75, 800x600_85, 1024x768_60, 1024x768_70, 1024x768_75, 1024x768_85, 1152x864_75, 1280x720_50, 1280x720_60, 1280x720p_60, 1280x768_59, 1280x768_60, 1280x768_74, 1280x768_75, 1280x768_85, 1280x800_60, 1280x960_60, 1280x960_85, 1280x1024_60, 1280x1024_75, 1280x1024_85, 1360x768_60, 1440x900_60, 1440x900_75, 1440x900_85, 1400x1050_60, 1400x1050_75, 1600x1200_60, 1680x1050_60, 1920x1080i_50, 1920x1080i_60, 1920x1080p_24, 1920x1080p_25, 1920x1080p_30, 1920x1080p_50, 1920x1080_60, 1920x1080p_60, 1920x1200_59, 1920x1200_60, 3840x2160p_24, 3840x2160p_25, 3840x2160p_30, 4096x2160p_24, 4096x2160p_25, 4096x2160p_30, 3840x2160p_50, 3840x2160_50, 3840x2160p_60, 3840x2160p_60CVR, 4096x2160p_50, 4096x2160p_60

- (3) Save EDID: Save the current selected EDID information.
 - (4) Load EDID: Load the Custom EDID to the Custom. Select “Custom” is the loaded EDID.
 - (5) HDCP Compliance: Tick the checkbox to enable HDCP compatibility for the corresponding input, which will transmit HDCP protected content (default setting); Untick the checkbox to disable HDCP compatibility for the corresponding input, which will transmit non- HDCP protected content.
- ### 3. Output Setting:
- (1) HDCP Compliance: Click the drop-down menu to select Auto/HDCP1.4/HDCP2.2/NO that the HDMI output supports.
 - (2) Save EDID: Save the EDID information of the display device.

Audio

The Audio page is used to control the audio.

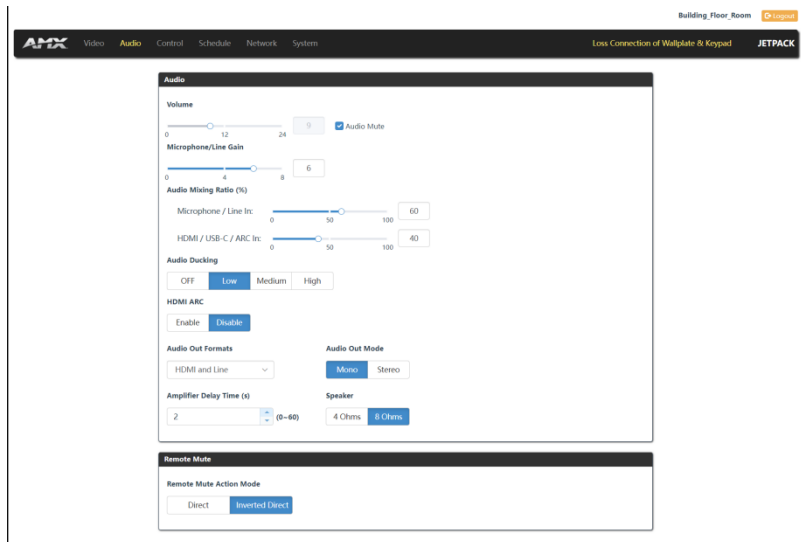

1. Audio:
 - (1) Volume: Move the slider to adjust the output audio volume of the AMP OUT and AUDIO OUT port on JPK-1300 RX. Check "Audio Mute" to mute audio output.
 - (2) Microphone/Line Gain: Move the slider to adjust the output audio volume of the MIC/LINE IN port on JPK-1300 RX.
 - (3) Audio Mixing Ratio (%): Move the slider to adjust the audio mixing ratio of Microphone/Line In or HDMI/USB-C/ARC-In (Ratio range: 0~100%).
 - (4) Audio Ducking: Click to disable the audio ducking function, or set the volume of digital background sound.
 - (5) HDMI ARC: Click to enable/disable the HDMI ARC function.
 - (6) Audio Out Formats: Click the drop-down menu to select the audio output port.
 - (7) Audio Out Mode: Click to select the audio output mode (Mono/Stereo).
 - (8) Amplifier Delay Time (s): Click the up/down arrow to set the time for amplifier delay output (Time range: 0~60s).
 - (9) Speaker: Click to select the speaker impedance (4 Ohms/8 Ohms).
2. Remote Mute: Click to select the Remote Mute Action Mode.
 - Direct: The REMOTE MUTE 2PIN is closed, the audio will be mute.
 - Inverted Direct: The REMOTE MUTE 2PIN is open, the audio will be mute.

Control

1. RS-232 Settings:
 - (1) RS-232 Port: Click to enable/disable the RS-232 serial port.
 - (2) RS-232 Mode: Click to select the RS-232 serial mode (Host/Client).
 - (3) Power On/Off Display: Click "ON" to send the "Power On Display" RS-232 command; Click "OFF" to send the "Power Off Display" RS-232 command.
 - (4) Set Serial Port output: Click the down arrow to respectively set the Baud Rate, Parity Bits, Data Bits, Stop Bits.
 - (5) Set RS-232 command:

End Flag: Click to select the ending flag after each RS-232 command (NONE/\r/\n/\r\n).

Format: Click to select the RS-232 command Format (ASCII/Hex).

Power On/Off Display command: Enter the RS-232 command to power on/off the display (supporting two commands), and click the up/ down arrow to set the Delay time (Time range: 0~2000ms).

2. IR Settings:

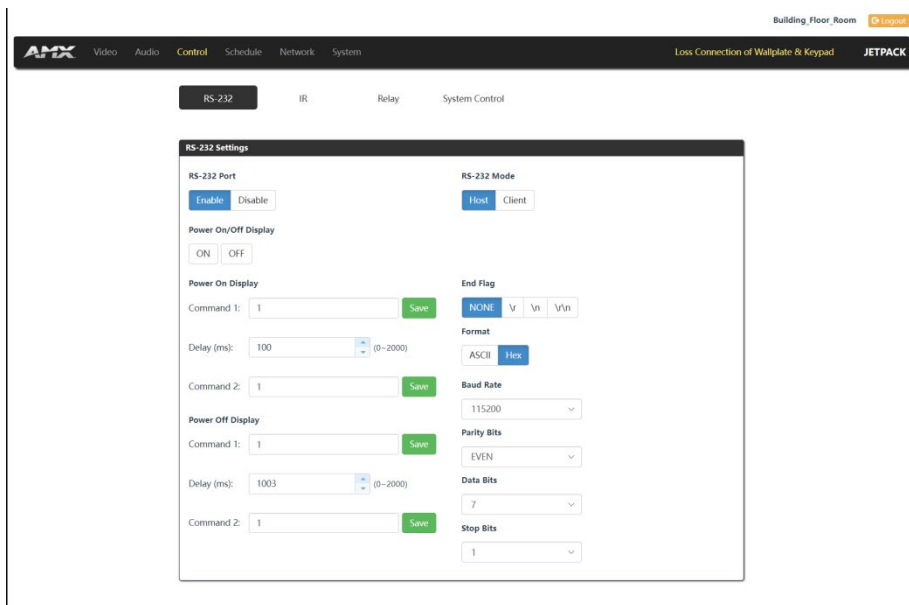

- (1) Power On/Off Display: Click "ON" to send the "Power On Display" IR command; Click "OFF" to send the "Power Off Display" IR command.
- (2) Learn: Click to learn the IR command, then use the remote control to learn by aligning with the IR window of JPK-1300 TX.
- (3) Save: Copy the IR CCF code to the blank window, and then click "Save" to save.

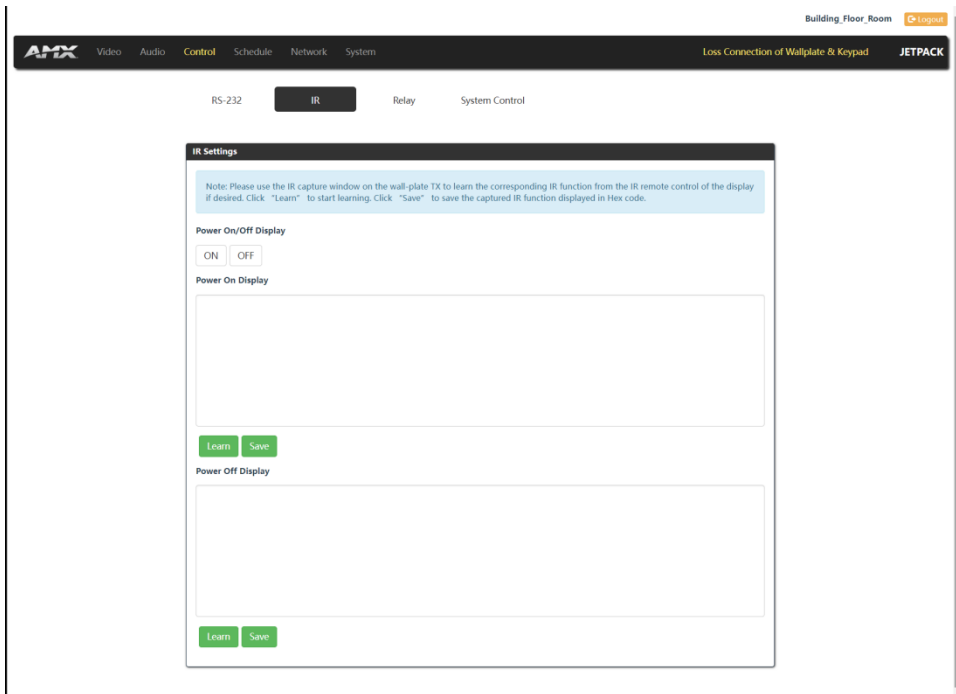

3. Relay Settings:

- (1) Screen Up/Down: Click "Up" to trigger Relay 1 open/closed; Click "Down" to trigger Relay 2 open/closed.
- (2) Relay Normal State: Click to select the Relay state (Normally Open/Normally Closed).
- (3) Relay Port Assignment: Click to select Screen Up/Screen Down for Relay 1 and Relay 2 respectively.
- (4) Relay Mode: Click to select Momentary (To be open/closed briefly) or Latch (To be open/closed for a long time).
- (5) Momentary Time (s): Click the up/down arrow to set the time for Momentary (Time range: 0~120s).

4. System Control:

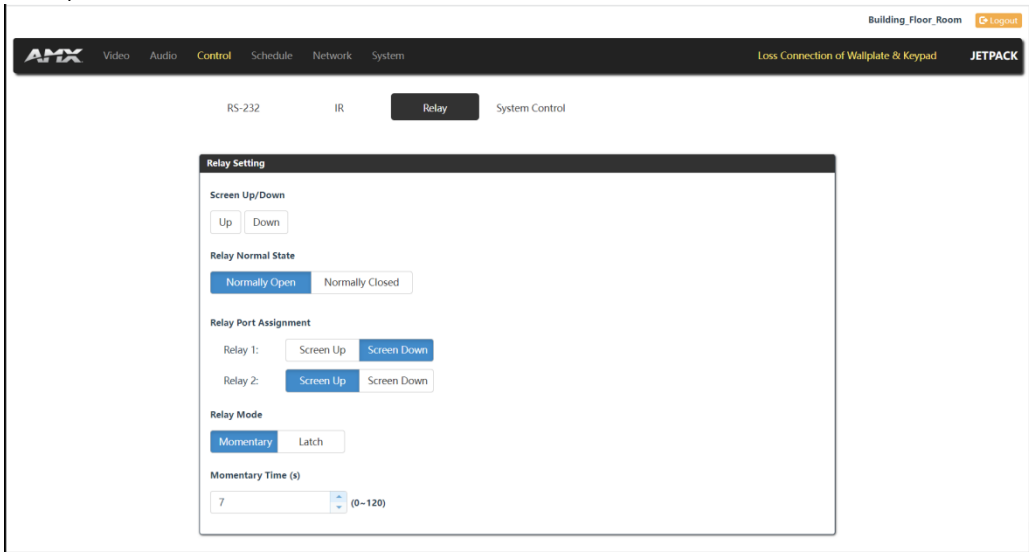

- (1) System: Click "ON" to power on the system; Click "OFF" to power off the system.
- (2) Display: Click "ON" to execute the CEC/RS-232/IR Power On or Screen Up action; Click "OFF" to execute the CEC/RS-232/IR Power Off or Screen Down action.
- (3) Auto Display On/Off: Click to select Enable/Disable. When "Enable" is selected, the system will detect whether there is video signal, if there is no video signal, it will execute the CEC/Serial/IR Power Off or Screen Down action.
- (4) Set the Delay time for the CEC/RS-232/IR Power Off or Screen Down action to be executed after there is no active video.
- (5) Respectively set the Manual Power On/Off and the Delay Time for the CEC/Serial/IR/Relay.

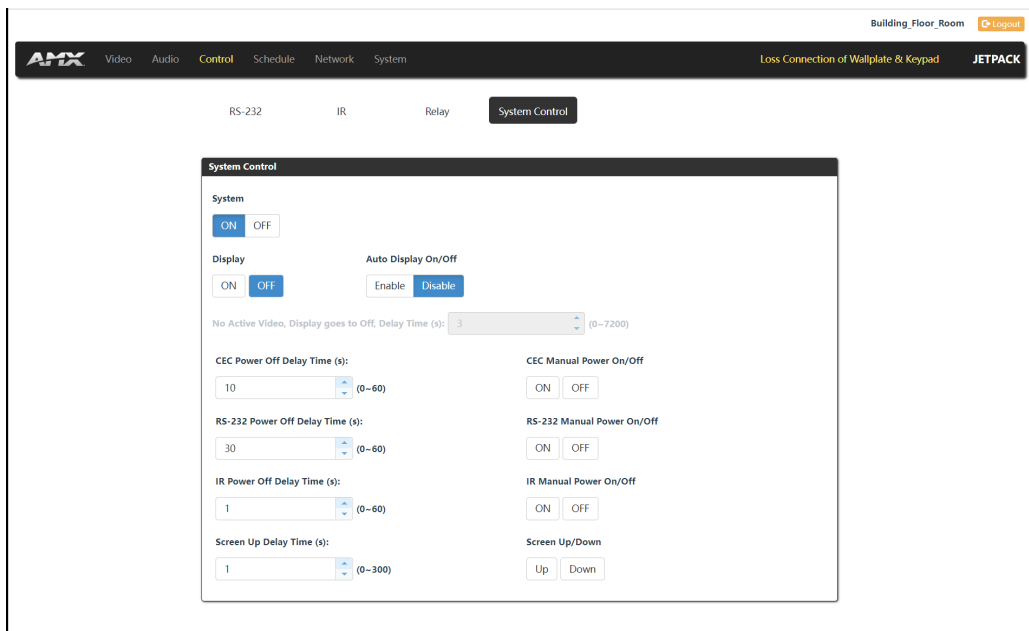

Schedule

The Schedule page is used to make presets.

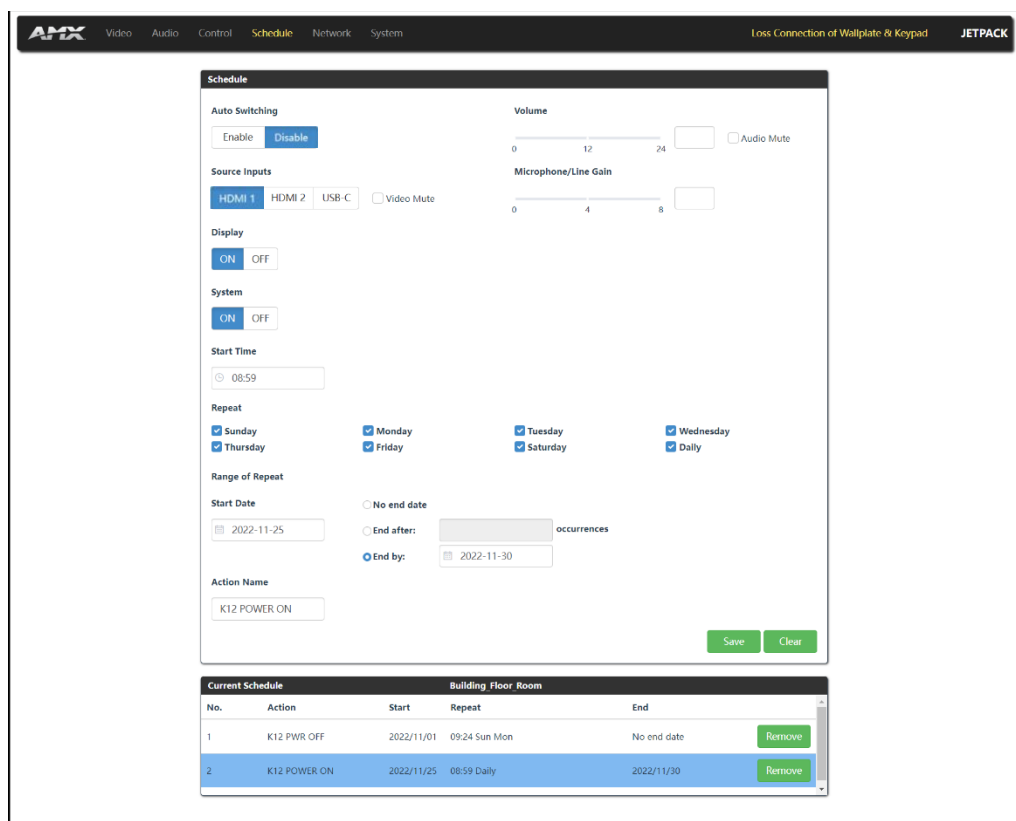

For example, for the preset of JPK-1300 POWER ON function, set parameters as shown in the above figure:

Select Disable for Auto Switching, set the Volume to 8, set Microphone/Line GAIN to 0, select "HDMI 1" as the input source, set Display and System to "ON"; Set the start time to "08:59", set the repeat operation (select "Daily"); Set the start date to "2022-11-25" and end date to "2022-11-30". Finally, name the preset function to be JPK-1300 POWER ON. The above Settings mean that JPK-1300 POWER ON will be performed at 8:59 every day from November 25, 2022 to November 30, 2022.

Network

The Network page is used to respectively make IPV4/ IPV6/802.1x Network Settings for the System, as shown in the figures below.

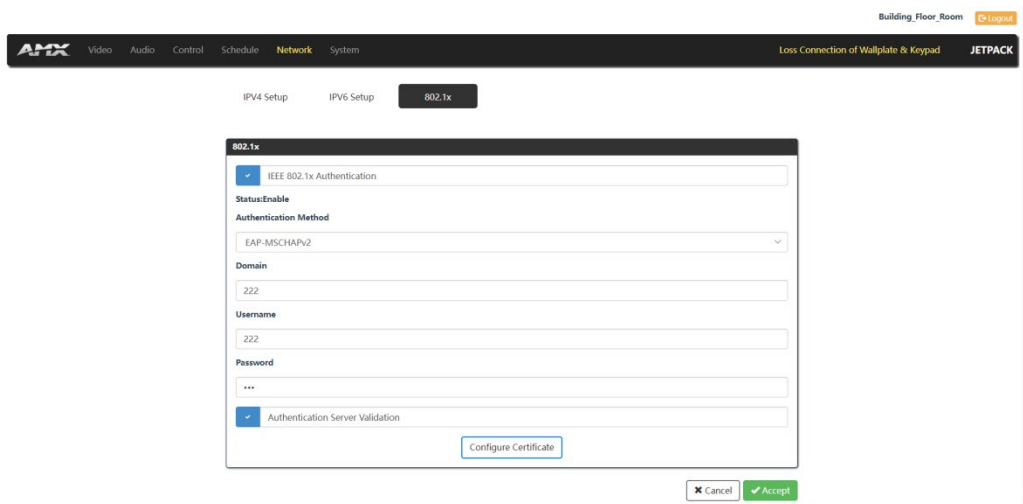
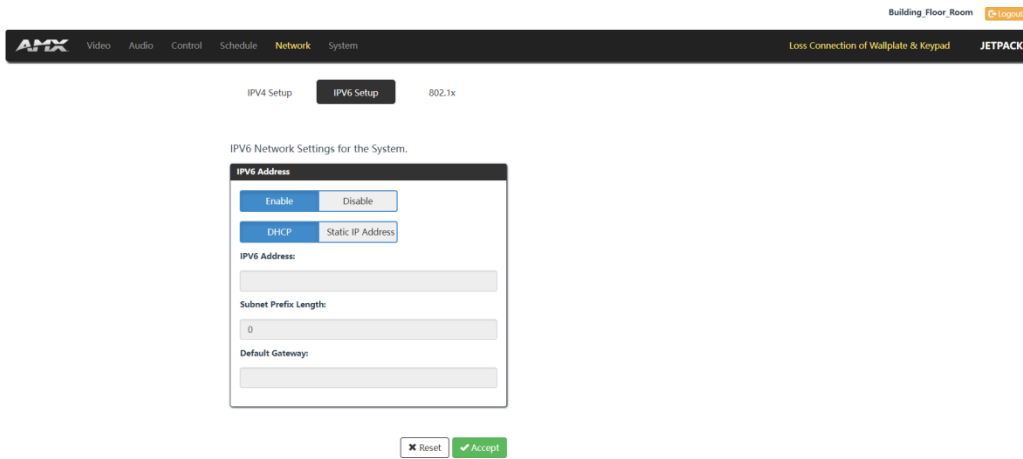
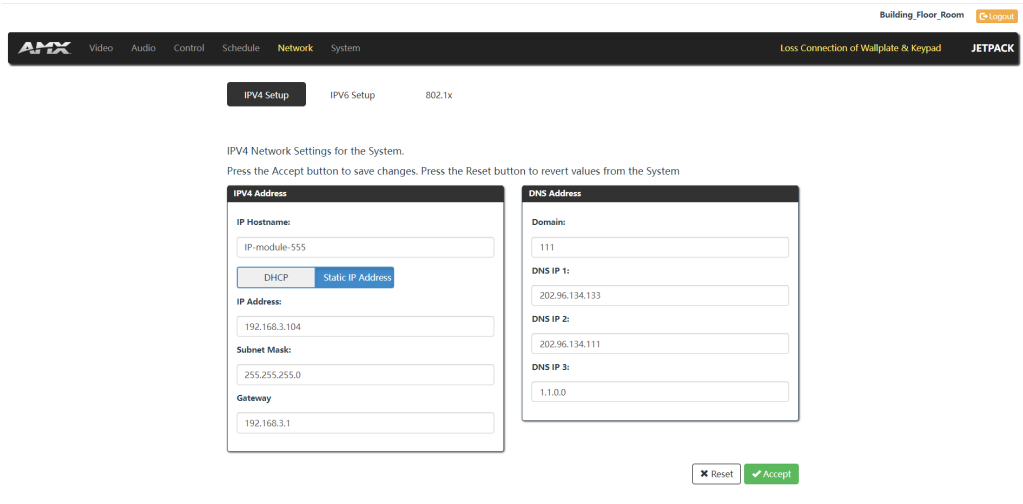

After setting, press the "Accept" button to save changes, or press the "Reset" button to revert values from the System.

System

1. General Settings:

- (1) Label Setting: Set the Web Label name.
- (2) Keypad Setting: Move the slider to adjust the Keypad backlight brightness (Range: 0~100).
- (3) Data and Time Setting: Set the data and time for the system.
- (4) Firmware Version: Display the software versions of JPK-1300 RX/TX/Keypad/Web.
- (5) Firmware Update: Click "Load File" to load the firmware file to be updated, and then click "Apply" to update.
- (6) Device Configuration: Click to save or load the Web page configurations.
- (7) Device Log: Click to save log files.
- (8) System: Click "Reboot" to reboot the system; click "Factory Default" to restore the system.

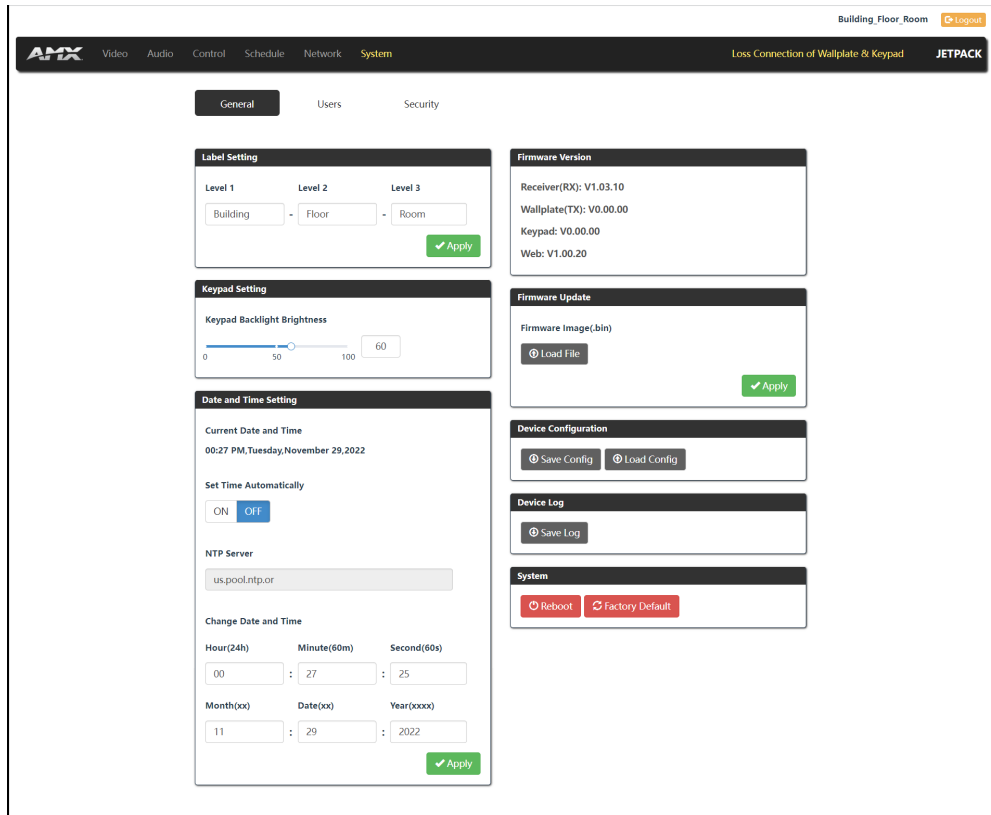

2. Users Settings:

The Users section is used to change and set the Web login password.



3. Security Settings:
The Security section is used for Network security settings.

The screenshot displays the ANX web interface for Security Settings. The top navigation bar includes 'Video', 'Audio', 'Control', 'Schedule', 'Network', and 'System'. The 'System' menu is active, showing 'Loss Connection of Wallplate & Keypad' and 'JETPACK'. The 'Security' tab is selected, with sub-tabs for 'General', 'Users', and 'Security'. The interface is divided into four main sections:

- Device Discovery:** A text input field for 'Device Discovery Pin Code' containing '00000000' and an 'Apply' button.
- SSH Account:** A section with an 'Access' toggle set to 'ON', a 'Username' input field, a 'Password' input field, and an 'Apply' button.
- Telnet Account:** A section with an 'Access' toggle set to 'ON', a 'Username' input field, a 'Password' input field, and an 'Apply' button.
- Upload HTTPS Certificate:** A section for uploading certificates, including fields for 'Private Key(.key):' (server.key), 'Certificate(.pem .crt):' (server.pem), and a 'Password:' field, with an 'Upload' button.
- Upload 802.1x Certificate:** A section for uploading certificates, including fields for 'Root CA:', 'Private Key(.key):', 'Certificate(.pem):', and a 'Password:' field, with an 'Upload' button.

Firmware Upgrade

JPK-1300 supports upgrade the firmware through the PC tool and Web UI control.

Before Starting

1. Verify that you have the latest version of PC tool and Web UI on your PC.
 2. Download the latest firmware file to your PC. (Place firmware files on a local drive for the fastest throughput.)
- Verify the following:
- a) Verify that an Ethernet/RJ-45 cable is connected from the JPK-1300 RX to the same network as the control system.
 - b) Verify the JPK-1300 unit is powered ON.

Upgrade Operation

Please follow the steps below to upgrade the firmware through the PC tool:

Step 1. Launch the PC tool “AMX Jetpack Manager” and select the UPDATE tab.

Step 2. Click the checkbox at the DEVICE LIST to select devices.

Note: You can select certain device or one Floor devices or one Building devices to upgrade in batches at the same time.

Step 3. Click “Select Firmware File” to select the firmware files to be upgraded, and then click “Update All” to start upgrading.

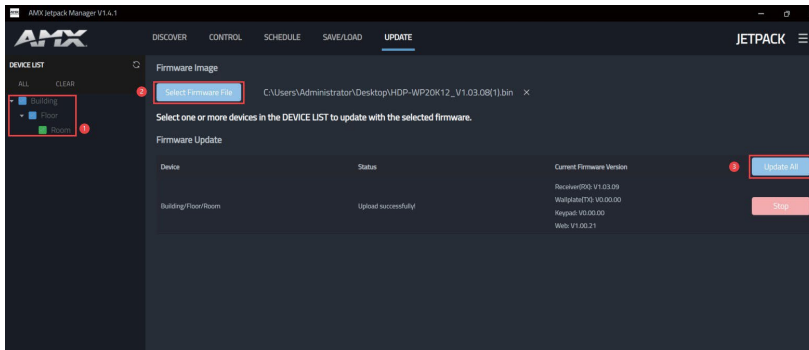

The upgrade is divided into several stages:

Stage 1. Upload the firmware file to the device. (In this state, clicking Stop on the right can stop the upgrade.)

Stage 2. Start to upgrade.

Stage 3. Upgrading.

Stage 4. Upgrade is complete or failed. At this time, the system displays the number of devices that have been successfully upgraded or failed to be upgraded.

Note: When upgrading a duplicate version, it will prompt that the upgrade cannot be repeated.

Please follow the steps below to upgrade the firmware through the Web UI control:

Step 1. Login the Web UI and select the General page of the System tab.

Step 2. Click "Load File" in "Firmware Update" to load the firmware file to be upgraded, and then click "Apply" to start upgrading.

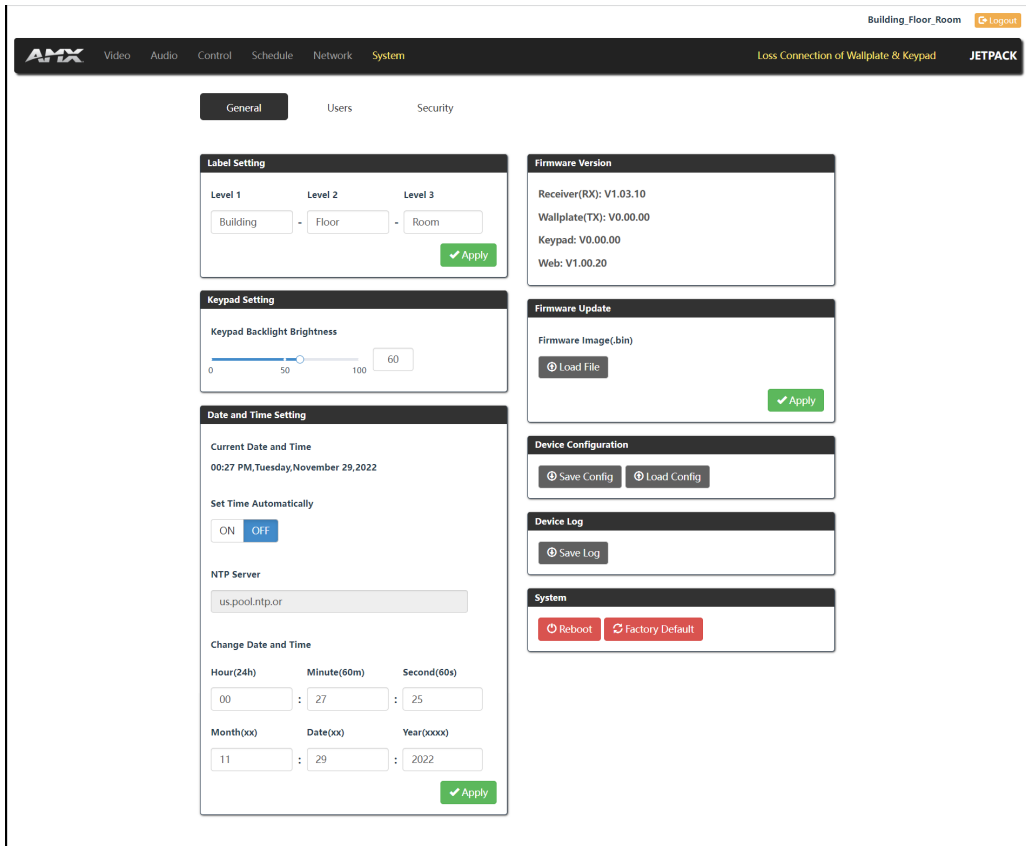

Note: Do not power off the device until it has been successfully upgraded.

Troubleshooting

1. **Power:** Ensure all devices are powered on.
2. **Indicator:** Ensure all LED indicators of the JPK-1300 are normal according to the Hardware Reference Manual.
3. **Devices:** Ensure picture can be shown normally when directly connecting a source a display device.
4. **Cable:** Plug the HDMI/Cat X cable in and out or connect a different HDMI/Cat X cable. Ensure the specific cable length is within the available transmission range according to the Specifications Section.
5. **Compatibility:** Test other source and display devices to determine correct compatibility.

API Command Set

The API Command list support sent by TCP/IP interface (Telnet and SSH) and by Serial port for JPK-1300 Kit

Command Format Notes:

1. In the Command Example sections of this document, <CR> indicates a carriage return as defined by your control method (e.g., \x0d, \$0d, 00x0d, 0x0d, 0dH). <CRLF> is also supported, but not required.
2. In the Command Example sections of this document, “:” indicates the following are command variants as defined by the command “<null>” is also supported.
3. In the Command Example sections of this document, “,” distinguish between two variables as defined by the command.
4. When issuing commands, it is best practice to wait for the command response before sending another. Otherwise, you must allow at least half a second between commands (when sending them back-to-back).

Welcome Banner with and without Security Enabled:

1. Without Telnet security enabled, a session will begin with a welcome banner similar to the following:
Welcome to JPK-1300 Kit v1.0.0 Copyright AMX LLC 2022
>
2. If Telnet security is enabled, user credentials are required:
Enter username: admin
Enter protected password: ****
Welcome to JPK-1300 Kit v1.0.0 Copyright AMX LLC 2022
>

Note: When security is enabled, a user can retry logging in three times before being disconnected.

Telnet Username and Password

The following commands are used to set the Telnet username and password for a Telnet connection: Set

Telnet Username
Set Telnet Password

By default, both the username and password are blank (empty strings). Performing a factory reset on the device with the Rest ID Push button will return these values to that default.

Username – Setting the Username will have no effect if the password remains blank (empty string). That is, defining the username alone will not result in Telnet prompting for a user login.

Password – Setting the Password will cause Telnet to prompt for a user login, whether the username has been defined or not. If the username has been defined, this value must be entered.

However, since the password can be set independently of the username, it’s possible to have a password defined, but the username still at its default (blank, empty string). In this case do not enter anything for the username when prompted. Simply press Enter, which will then present the password prompt. Here, the defined password must be entered in order to successfully open the Telnet session.

Additional Notes:

1. Both the Telnet username and password are case-sensitive.
2. Three consecutive, unsuccessful attempts to log in to Telnet will cause the Telnet window to close.
3. Re-launching Telnet will again present the login prompt, with a fresh “batch” of login attempts.
4. If a Telnet login fails because of an incorrect username, an “Invalid Password” message will appear (as opposed to an “Invalid Username” message).
5. The username and password are saved after reboot or power cycle.
6. The username and password are deleted/removed after a factory reset.

System Commands

No.	Command	Function Description	Example
1	? Or help	Display the commands listed in the table	<pre>>help<CR> ----- Help----- (Extended diag messages are OFF) ---System Commands--- ? Or help This list ping pint to specified ip address fwversion device Request the firmware vesrion of the ---Network Commands---</pre>
2	?<command> Variables: <command> = "JPK-1300 API commands in the list"	Show details about the specified command function	<pre>>?set vidin hdcp<CR> ----- Description: Set the HDCP mode for input Example: Command send: set vidin hdcp,off response:set input hdcp to off >-----</pre>
3	ping <ipv4 address> ping -6 <ipv6 address> Variables: <ipv4 address>= ipv6 address <ipv6 address>= ipv6 address	Ping to specified IP address	<pre>>ping 192.168.1.250<CR> PING 192.168.1.250 (192.168.1.250): 56 data bytes 64 bytes from 192.168.1.250: seq=0 ttl=64 time=0.625 ms 64 bytes from 192.168.1.250: seq=1 ttl=64 time=0.587 ms 64 bytes from 192.168.1.250: seq=2 ttl=64 time=0.580 ms 64 bytes from 192.168.1.250: seq=3 ttl=64 time=1.388 ms 64 bytes from 192.168.1.250: seq=4 ttl=64 time=0.593 ms --- 192.168.1.250 ping statistics --- 5 packets transmitted, 5 packets received, 0% packet loss round-trip min/avg/max = 0.580/0.754/1.388 ms >ping -6 2022:a:b:c::b2<CR> PING 2022:a:b:c::b2 (2022:a:b:c::b2): 56 data bytes 64 bytes from 2022:a:b:c::b2: seq=0 ttl=63 time=2.093 ms 64 bytes from 2022:a:b:c::b2: seq=1 ttl=64 time=2.083 ms 64 bytes from 2022:a:b:c::b2: seq=2 ttl=64 time=2.057 ms 64 bytes from 2022:a:b:c::b2: seq=3 ttl=64 time=1.960 ms 64 bytes from 2022:a:b:c::b2: seq=4 ttl=64 time=1.962 ms --- 2022:a:b:c::b2 ping statistics --- 5 packets transmitted, 5 packets received, 0% packet loss round-trip min/avg/max = 1.960/2.031/2.093 ms</pre>
4	fwversion	Request the firmware version of the device	<pre>>fwversion<CR> Receiver: V1.00 Wallplate: V1.01 Keypad:V1.11 Web:V2.0 ></pre>
5	reboot	Reboot the device	<pre>>reboot<CR> Rebooting..... ></pre>
6	reset factory	Forces the unit to a factory state (except for IP Settings)	<pre>>reset factory<CR> Resetting device to factory default parameters. Device will automatically reboot shortly. Do NOT power off. ></pre>
7	get sn Default Value: As set in factory	Get device serial number	<pre>>get sn<CR> Serial Number:123456789 ></pre>

System Commands

No.	Command	Function Description	Example
8	<pre>set serial <on off></pre> <p>Default Value: on</p>	Set serial port on or off	<pre>>set serial on<CR> Serial port is set to on > >set serial off<CR> --Notice: Serial port cannot response to serial command when serial off.-- Would you like to set serial port to off? Y/N ->y<CR> Serial port is off ></pre>
9	<pre>get serial mode</pre> <p>Variables: <mode>= { host client }</p> <p>Default Value: host</p>	Set serial control mode	<pre>>get serial mode <CR> Serial port is set to host mode to control external device ></pre>
10	<pre>set serial mode</pre> <p>Variables: <mode>= { host client }</p> <p>Default Value: host</p>	Set serial control mode	<pre>>set serial mode<CR> Notice: Serial port cannot control external device when set to be client, which is used for external device to control of the device Enter serial mode (host or client): host -> client<CR> Serial port is set to be client mode ></pre>
11	<pre>get baud</pre> <p>Variables: <baud> = 115200 57600 38400 19200 9600(default) 4800 2400 <data> = 7 8(default) <parity> = even odd none(default) <stop> = 1(default) 2</p> <p>Default Value: 9600,n,8,1</p>	Get serial port current communicate parameters	<pre>>get baud<CR> --Current serial setting-- baud rate:9600 data bit:8 parity:none stop bit:1 ></pre>
12	<pre>set baud</pre> <p>Variables: <baud> = 115200 57600 38400 19200 9600(default) 4800 2400 <data> = 7 8(default) <parity> = even odd none(default) <stop> = 1(default) 2</p> <p>Default Value: 9600,n,8,1</p>	Sets serial port communicate parameters	<pre>>set baud<CR> --Serial port setting-- Enter baud rate(115200,57600,38400,19200, 9600,4800,2400):9600->115200<CR> Enter data bit(8 or 7):8 ->7<CR> Enter parity (E for Even, O for Odd, N for none): N->O<CR> Enter stop bit (1 or 2):1->2<CR> --You have entered: Baud rate:115200 Data bit:7 Parity:odd Stop bit:2 Would you like to save the new settings? Y/N -> y<CR> New settings were saved ></pre>
13	<pre>set time auto <on off></pre> <p>Default Value: on</p>	Set time automatically on or off	<pre>>set time auto on<CR> Time auto is set to on > >set time auto off<CR> --Notice: Device time cannot synchronize with network when set time auto off.-- Would you like to set time auto to off? Y/N ->y<CR> Time auto is set to off ></pre>

System Commands

No.	Command	Function Description	Example
14	get ntp Default Value: us.pool.ntp.org	Get ntp server setting	>get ntp<CR> --Current ntp server: us.pool.ntp.org >
15	set ntp Default Value: us.pool.ntp.org	Set ntp server	>set ntp<CR> Please input ntp server: current ntp server: us.pool.ntp.org New ntp server: asia.pool.ntp.org<CR> Would you like to save this setting(Y/N) y<CR> Setting is ok >
16	get system Default Value: on	Set device system state	>get system <CR> The device is system on > >get system<CR> The device is system off Notice: device cannot receive signal when system off, it need send system on command to enter normal working mode >
17	set system <on off> Default Value: on	Set device system on or off. NOTICE: Device need be recalled from System off by System on command or press SYSTEM button on Keypad, cannot auto recall by active input signal.	>set system on<CR> set device system on > >set system off<CR> Notice: device cannot receive signal when system off, it need send system on command to enter normal working mode Would you like to set device system off? Y/N ->y<CR> The device is system off >
18	get label Variables: evel 1 = Maximum 20 digital length level 2 = Maximum 20 digital length level 3 = Maximum 20 digital length Default Value: level 1= Building level 2= Floor level 3= Room	Get device's label	>get label<CR> --Current device label-- Level 1: Building Level 2: Floor Level 3: Room >
19	set label Variables: evel 1 = Maximum 20 digital length level 2 = Maximum 20 digital length level 3 = Maximum 20 digital length Default Value: level 1= Building level 2= Floor level 3= Room	Set device's label	>set label<CR> Enter level 1:AMX ->Building<CR> Enter level 2:JPK-1300 ->Floor<CR> Enter level 3:12345678901->Room<CR> --You have entered: Level 1:Building Level 2:Floor Level 3:Room Would you like to save the new label? Y/N -> y<CR> New settings were saved >
20	get button brightness Variables: <brightness> = 0~100 Default Value: 50 (TBD)	Get device's key button brightness	>get button brightness<CR> Current button brightness is 50 >
21	set button brightness Variables: <brightness> = 0~100 Default Value: 50 (TBD)	Set device's key button brightness	>set button brightness<CR> Enter brightness:50 -> 100<CR> Would you like to save the new brightness? Y/N -> y<CR> New setting was set >
22	exit	Close telnet/ssh window session NOTE: Don't support the command send by Serial port	>exit<CR>

Network Commands

No.	Command	Function Description	Example
1	<p>get friendly</p> <p>Variables: friendly name = maximum 20 digital length</p> <p>Default Value: model with last 7 digits of serial # in Capital Letters (e.g. JPK-1300-0050425)</p>	Get device's IP hostname	<pre>>get friendly<CR> --Current device friendly name: JPK-1300-0050425 ></pre>
2	<p>set friendly</p> <p>Variables: friendly name = maximum 20 digital length</p> <p>Default Value: model with last 7 digits of serial # in Capital Letters (e.g. JPK-1300-0050425)</p>	Set device's IP hostname	<pre>>set friendly<CR> Please input friendly name: Old friendlyname: JPK-1300-0050425 New friendlyname: 111<CR> Would you like to save this setting(Y/N) y<CR> Setting is ok , you should reboot that make it effective ></pre>
3	<p>get ip</p> <p>Variables: host name = maximum 20 digital length ip type = dhcp static ip netmask gateway</p> <p>Default Value: IP Address Mode: DHCP IP Address(for static mode):192.168.1.2 Netmask(for static mode):255.255.255.0 Gateway(for static mode):192.168.1.1 MAC Address: as set in factory</p>	Show the IP configuration of this device.	<pre>>get ip<CR> IP Settings ----- HostName: JPK-1300-0050425 Type: Static IP Address: 192.168.1.3 Subnet Mask: 255.255.255.0 Gateway IP: 0.0.0.0 MAC Address: 00:60:9f:a4:46:f3 ></pre>
4	<p>set ip</p> <p>Variables: host name = maximum 20 digital length ip type = dhcp static ip netmask gateway</p> <p>Default Value: IP Address Mode: DHCP IP Address(for static mode):192.168.1.2 Netmask(for static mode):255.255.255.0 Gateway(for static mode):192.168.1.1 MAC Address: as set in factory</p>	Setup the IP configuration of this device.	<pre>>set ip<CR> --Enter New Values or just hit Enter to keep current settings-- Enter Host Name: JPK-1300-0050425 -> ROOM1<CR> Enter IP type. Type D for DHCP, or S for Static IP and then Enter: DHCP ->s<CR> Enter IP Address: 192.168.1.2 ->192.168.1.3<CR> Enter Subnet Mask: 255.255.255.0 -><CR> Enter Gateway IP: 192.168.1.1 ->0.0.0.0<CR> --You have entered: Host Name ROOM1 Type Static IP IP Address 192.168.1.3 Subnet Mask 255.255.255.0 Gateway IP 0.0.0.0 Is this correct? Type Y or N and Enter -> Y<CR> Settings written. Device must be rebooted to enable new settings. ></pre>

Network Commands

No.	Command	Function Description	Example
5	<pre>get dns</pre> <p>Variables: dns1 dns2 dns3</p> <p>Default Value: Domain Name: amx.com DNS1(for static mode):8.8.8.8 DNS2(for static mode):8.8.4.4 DNS3(for static mode):9.9.9.9</p>	Get device's DNS address	<pre>>get dns DNS Servers ----- Domain suffix: amx.com Entry 1: 192.168.1.1 Entry 2: 192.168.1.1 Entry 3: 192.168.1.1 ></pre>
6	<pre>set dns</pre> <p>Variables: dns1 dns2 dns3</p> <p>Default Value: Domain Name: amx.com DNS1(for static mode):8.8.8.8 DNS2(for static mode):8.8.4.4 DNS3(for static mode):9.9.9.9</p>	Set device's DNS address	<pre>>set dns<CR> -- Enter New Values or just hit Enter to keep current settings -- Enter Domain Suffix: amx.com -><CR> Enter DNS Entry 1 : 192.168.20.5 ->8.8.8.8<CR> Enter DNS Entry 2 : 12.18.110.8 -><CR> Enter DNS Entry 3 : 12.18.110.7 -><CR> You have entered: Domain Name: amx.com DNS Entry 1: 8.8.8.8 DNS Entry 2: 12.18.110.8 DNS Entry 3: 12.18.110.7 Is this correct? Type Y or N and Enter -> Y<CR> Settings written. Device must be rebooted to enable new settings ></pre>
7	<pre>renew dhcp</pre>	Renews the DHCP lease (may cause telnet disconnection)	<pre>>renew dhcp<CR> You may need to re-establish the telnet session since the device will re-acquire an IP address lease. ></pre>
8	<pre>get ipv6</pre> <p>Variables: pv6 = enable disable ipv6 type = dhcp static ip static ipv6 address subnet mask prefix length ipv6 gateway</p> <p>Default Value: IPv6 Enabled/Disabled: Disable IPv6 Type: DHCP Address: 0:0:0:0:0:0:0:0 Mask Prefix: 128 Gateway: none</p>	Show the IPV6 configuration of this device.	<pre>>get ipv6<CR> IPV6 Settings ----- IPv6 Enabled/Disabled: Enabled IPv6 Type: DHCP Address: 2001:0DB8:ABCD:0012:1234:: Mask Prefix: 80 Gateway: none ></pre>
9	<pre>set ipv6</pre> <p>Variables: pv6 = enable disable ipv6 type = dhcp static ip static ipv6 address subnet mask prefix length ipv6 gateway</p> <p>Default Value: IPv6 Enabled/Disabled: Disable IPv6 Type: DHCP Address: 0:0:0:0:0:0:0:0 Mask Prefix: 128 Gateway: none</p>	Setup the IPV6 configuration of this device.	<pre>>set ipv6<CR> --- Enter New Values or just hit Enter to keep current settings IPv6 (E)nable/(D)isable: Disabled ->E<CR> IPv6 Type: D for DHCP, S for Static: DHCP ->S<CR> Enter Static IPv6 Address: 0:0:0:0:0:0:0:0 -> 2001:0DB8:ABCD:0012::<CR> Enter Subnet Prefix Length 128 -> 64<CR> Enter Static IPv6 Default Gateway (or N for NONE): <none> ->N<CR> You have entered: IPv6 Enabled/Disabled: Enabled IPv6 Type: Static Address: 2001:0DB8:ABCD:0012:: Mask Prefix: 64 Gateway: none Is this correct? Type Y or N and Enter -> Y<CR> Settings written. Device must be cold rebooted to enable new settings.></pre>

Security Commands

No.	Command	Function Description	Example
1	set telnet port Variables: 0 = disable telnet 23 = enable telnet Default Value: 23	Sets the device's IP port listened to for Telnet connections. NOTE: This command requires a reboot to enable new settings. IMPORTANT: If you set the Telnet port to "0" to disable it, you will need to reset it in WebGUI	<pre>>set telnet port<CR> Current telnet port number = 23 Enter new telnet port number(0 = disable telnet) ->25<CR> Setting telnet port number to 25 New telnet port number set, reboot the device for the change to take effect. ></pre>
2	set telnet username Variables: username = maximum 20 digital length Default Value: ""(blank,no username)	Sets the Username for a secure Telnet session. Default = blank (no username required)	<pre>>set telnet username<CR> Enter Telnet new username ->123<CR> Would you like to set this username (y/n) ->y<CR> (please set telnet password) Changed && Saved ></pre>
3	set telnet password Variables: password = maximum 10 digital length Default Value: ""(blank,no password)	Sets the password for a secure Telnet session. Default = blank (no password required)	<pre>>set telnet password<CR> Enter Telnet new password ->456<CR> Would you like to set this password (y/n) ->y<CR> Changed && Saved ></pre>
4	set ssh port Variables: 0 = disable SSH 22 = enable SSH Default Value: 22	Sets the device's IP port listened to for SSH connections. NOTE: This command requires a reboot to enable new settings. IMPORTANT: If you set the SSH port to "0" to disable it, you will need to reset it in WebGUI NOTE: This command is supported by SSH only, don't support by telnet	<pre>>set ssh port<CR> Current ssh port number = 22 Enter new ssh port number(0 = disable ssh) ->26<CR> Setting ssh port number to 26 New ssh port number set, reboot the device for the change to take effect. ></pre>
5	set ssh username Variables: username = maximum 20 digital length Default Value: admin	Sets the Username for a secure SSH session. NOTE: This command is supported by SSH only, don't support by telnet	<pre>>set ssh username<CR> Enter SSH new username ->123<CR> Would you like to set this username (y/n) ->y<CR> (please set ssh password) Changed && Saved ></pre>
6	set ssh password Variables: password = maximum 10 digital length Default Value: admin	Sets the password for a secure SSH session. NOTE: This command is supported by SSH only, don't support by telnet	<pre>>set ssh password<CR> Enter SSH new password ->456<CR> Would you like to set this password (y/n) ->y<CR> Changed && Saved ></pre>

Video and Audio Commands (Direct Control)

No.	Command	Function Description	Example
1	<p>get auto switch mode</p> <p>Variables: <state> = enable disable</p> <p>Default Value: enable</p>	Get auto switch mode state for video output	<p>Command: get auto switch mode</p> <p>Return: get auto switch mode enable</p>
2	<p>set auto switch mode:<state></p> <p>Variables: <state> = enable disable</p> <p>Default Value: enable</p>	Set auto switch mode state for video output	<p>Command: set auto switch mode:disable</p> <p>Return: set auto switch mode manual</p>
3	<p>get switch CO</p> <p>Default Value: default auto switch input video priority: HDMI1 > HDMI2 > USB-C</p>	Get audio/video output are switched from which input	<p>Command: get switch CO</p> <p>Possible response message include:</p> <ul style="list-style-type: none"> ▪get switch audio and video from hdmi 1 for output ▪get switch audio and video from no usb-c for output ▪get switch audio from usb-c for output ▪get switch audio from hdmi-arc for output
4	<p>set switch CI<input channel></p> <p>Variables: <input channel>= { 1=hdmi1, 2=hdmi2, 3=usb-c }</p> <p>Default Value: default auto switch video priority: HDMI1 > HDMI2 > USB-C (If all of them have no active video in)</p>	Set switch audio and/or video input to the output port.	<p>Possible command send:</p> <ul style="list-style-type: none"> ▪set switch CI1 ▪set switch CI3 ▪set switch CI3 ▪set switch CI4 <p>Possible response message include:</p> <ul style="list-style-type: none"> ▪set switch audio and video from hdmi 1 for output ▪set switch audio and video from usb-c for output ▪set switch audio from usb-c for output ▪invalid switch
5	<p>get vidin res</p> <p>Variables: <resolution> = <H> x <V> <i p>,<Rate><Specific Info></p> <p>Default Value: “ ” (blank for no active input signal)</p>	Get active input video resolution	<p>Command: get vidin res</p> <p>Possible response message include:</p> <ul style="list-style-type: none"> ▪ get 1920x1080p,60 ▪ get no active video ▪ get unkonw format
6	<p>get vidin hdcp</p> <p>Variables: <hdcp_compliance>= on off</p> <p>Default Value: on</p>	Get hdcp mode for device input	<p>Command: get vidin hdcp</p> <p>Return: get hdcp compliance on for device input</p>
7	<p>set vidin hdcp:<hdcp_compliance></p> <p>Variables: <hdcp_compliance>= on off</p> <p>Default Value: on</p>	Set hdcp mode for device input	<p>Command: set vidin hdcp:off</p> <p>Return: set hdcp compliance off for device input</p>

Video and Audio Commands (Direct Control)

No.	Command	Function Description	Example
8	<p>get vidin edidmode</p> <p>Default Value: auto</p>	Get edid mode for the device input	<p>Command: get vidin edidmode</p> <p>Return: get device input edid mode set to auto</p>
9	<p>set vidin edidmode:<edid_mode></p> <p>Variables: <edid_mode> = { Auto Custom 800x600,60 800x600,72 800x600,75 800x600,85 848x480,60 848x480,75 848x480,85 1024x640,60 1024x768,60 1024x768,70 1024x768,75 1024x768,85 1152x864,75 1280x720,50 1280x720,60 1280x720p,60 1280x720p,100 1280x720p,120 1280x768,59 1280x768,60 1280x768,74 1280x768,75 1280x768,85 1280x768,85 1280x800,60 1280x960,60 1280x960,85 1280x1024,60 1280x1024,75 1280x1024,85 1360x764,60 1360x768,60 1440x900,60 1440x900,75 1440x900,85 1400x1050,60 1400x1050,75 1600x1200,60 1680x1050,60 1920x1080i,50 1920x1080i,60 1920x1080p,24 1920x1080p,25 1920x1080p,30 1920x1080p,50 1920x1080,60 1920x1080p,60 1920x1200,59 1920x1200,60 3840x2160p,24 3840x2160p,25 3840x2160p,30 4096x2160p,24 4096x2160p,25 4096x2160p,30 3840x2160p,50 3840x2160,50 3840x2160p,60 3840x2160p,60CVR 4096x2160p,50 4096x2160p,60 }</p> <p>Default Value: auto</p>	Set edid mode for the device input	<p>Command: set vidin edidmode:user define 1</p> <p>Return: set device input to user define 1 edid mode</p>

Video and Audio Commands (Direct Control)

No.	Command	Function Description	Example
10	<pre>get ediddata:<edid_ channel> Variables: <edid_source> = { native, (current active edid on device) sink (sink display edid attached on output) }</pre>	Get edid data used from specified channel	<p>Command: get ediddata:native</p> <p>Return: get native ediddata is: 00 FF FF FF FF FF FF 00 05 B8 00 11 04 00 00 00 1C 19 01 03 80 00 00 78 0E EE 95 A3 54 4C 99 26 0F 50 54 FF FF 80 D1 00 B3 00 A9 40 81 00 81 C0 81 80 8B C0 95 00 02 3A 80 18 71 38 2D 40 58 2C 45 00 40 84 63 00 00 1E 00 00 00 FC 00 41 4D 58 5F 48 44 4D 49 31 76 34 0A 20 00 00 00 FD 00 17 78 0F 66 11 00 0A 20 20 20 20 20 20 00 00 00 FA 00 D1 C0 A9 C0 90 40 81 40 01 01 01 01 0A 01 5F 02 03 30 70 67 03 0C 00 11 00 80 22 5F 10 20 22 1F 21 05 14 04 03 13 02 0E 0F 11 06 07 12 15 16 1D 1E 27 29 2A 2B 2C 2D 2F 30 31 01 23 09 07 07 1A 36 80 A0 70 38 1F 40 30 20 35 00 40 84 63 00 00 1A 46 37 80 70 72 38 22 40 70 C8 35 00 40 84 63 00 00 1C D1 3D 80 80 72 B0 26 40 78 C8 36 00 40 E8 63 00 00 1C 28 3C 80 A0 70 B0 23 40 30 20 36 00 40 E8 63 00 00 1A 00 00 00 00 00 00 45</p>
11	<pre>set ediddata:<edid_data> Variables: <edid_data> = 256byte EDID Data Default Value: "" (blank for no loaded custom edid data)</pre>	Set edid data for custom edid	<p>Command: set ediddata:00 FF FF FF FF FF FF 00 05 B8 00 11 04 00 00 00 1C 19 01 03 80 00 00 78 0E EE 95 A3 54 4C 99 26 0F 50 54 FF FF 80 D1 00 B3 00 A9 40 81 00 81 C0 81 80 8B C0 95 00 02 3A 80 18 71 38 2D 40 58 2C 45 00 40 84 63 00 00 1E 00 00 00 FC 00 41 4D 58 5F 48 44 4D 49 31 76 34 0A 20 00 00 00 FD 00 17 78 0F 66 11 00 0A 20 20 20 20 20 20 00 00 FA 00 D1 C0 A9 C0 90 40 81 40 01 01 01 01 0A 01 5F 02 03 30 70 67 03 0C 00 11 00 80 22 5F 10 20 22 1F 21 05 14 04 03 13 02 0E 0F 11 06 07 12 15 16 1D 1E 27 29 2A 2B 2C 2D 2F 30 31 01 23 09 07 07 1A 36 80 A0 70 38 1F 40 30 20 35 00 40 84 63 00 00 1A 46 37 80 70 72 38 22 40 70 C8 35 00 40 84 63 00 00 1C D1 3D 80 80 72 B0 26 40 78 C8 36 00 40 E8 63 00 00 1C 28 3C 80 A0 70 B0 23 40 30 20 36 00 40 E8 63 00 00 1A 00 00 00 00 00 00 45</p> <p>Return: set custom edid data to be: 00 FF FF FF FF FF FF 00 05 B8 00 11 04 00 00 00 1C 19 01 03 80 00 00 78 0E EE 95 A3 54 4C 99 26 0F 50 54 FF FF 80 D1 00 B3 00 A9 40 81 00 81 C0 81 80 8B C0 95 00 02 3A 80 18 71 38 2D 40 58 2C 45 00 40 84 63 00 00 1E 00 00 00 FC 00 41 4D 58 5F 48 44 4D 49 31 76 34 0A 20 00 00 00 FD 00 17 78 0F 66 11 00 0A 20 20 20 20 00 00 00 FA 00 D1 C0 A9 C0 90 40 81 40 01 01 01 0A 01 5F 02 03 30 70 67 03 0C 00 11 00 80 22 5F 10 20 22 1F 21 05 14 04 03 13 02 0E 0F 11 06 07 12 15 16 1D 1E 27 29 2A 2B 2C 2D 2F 30 31 01 23 09 07 07 1A 36 80 A0 70 38 1F 40 30 20 35 00 40 84 63 00 00 1A 46 37 80 70 72 38 22 40 70 C8 35 00 40 84 63 00 00 1C D1 3D 80 80 72 B0 26 40 78 C8 36 00 40 E8 63 00 00 1C 28 3C 80 A0 70 B0 23 40 30 20 36 00 40 E8 63 00 00 1A 00 00 00 00 00 45</p>
12	<pre>get vidout hdcp Default Value: auto</pre>	Get HDCP mode for output	<p>Command: get vidout hdcp</p> <p>Return: output is set to AUTO HDCP mode</p>

Video and Audio Commands (Direct Control)

No.	Command	Function Description	Example
13	set vidout hdcpc:<hdcpc_mode> Variables: <hdcpc_mode> = { AUTO HDCP2.2 HDCP1.4 NO-HDCP } Default Value: auto	Set HDCP mode for output	Command: set vidout hdcpc:hdcpc2.2 Return: output is set to HDCP2.2 mode
14	get vidout mute Variables: <state>= on off Default Value: off	Get video mute state	Command: get vidout mute Return: get video mute set to off for output
15	set vidout mute:<state> Variables: <state>= on off Default Value: off	Set video mute for output	Command: set vidout mute:on Return: set video mute to on for output
16	get audin mic gain Variables: <input_gain>= 0 ~ 8 Default Value: 8	Get microphone audio gain for input	Command: get audin mic gain Return: get microphone audio gain 8 for output
17	set audin mic gain:<input gain> Variables: <input_gain>= 0 ~ 8 Default Value: 8	Set microphone audio gain for input	Command: set audin mic gain:8 Return: set microphone audio gain 8 for output
18	get audout volume Variables: <output_volume>= 0 ~ 24 Default Value: 12	Get amplifier and line audio volume for output	Command: get audout volume Return: get audio out volume 12 for output
19	set audout volume:<output volume> Variables: <output_volume>= 0 ~ 24 Default Value: 12	Set amplifier and line audio volume for output	Command: set audout volume:14 Return: set audio out volume 14 for output
20	get audout amp delay Variables: <output_delay>= 0 ~ 60 second (1 second/stage) Default Value: 0 second	Get amplifier audio delay for output	Command: get audout amp delay Return: get amplifier audio delay 0s for output
21	set audout amp delay:<output delay> Variables: <output_delay>= 0 ~ 60 second (1 second/stage) Default Value: 0 second	Set amplifier audio delay for output	Command: set audout amp delay:30 Return: set amplifier audio delay 30s for output

Video and Audio Commands (Direct Control)

No.	Command	Function Description	Example
22	get audout mute Variables: <state>= on off Default Value: off	Get audio mute state	Command: get audout mute Return: get audio mute set to off for output
23	set audout mute:<state> Variables: <state>= on off Default Value: off	Set audio mute for output	Command: set audout mute:on Return: set audio mute to on for output
24	get audout format Default Value: all	Get audio output format	Command: get audout format Return: get audio format amp and line for output
25	set audout format:<format> Variables: <format>= { all hdmi amp line hdmi,amp hdmi,line amp,line } Default Value: all	Set audio output format NOTE: When Input HDMI embedded audio is not PCM audio (such as compressed Dolby/DTS audio), auto MUTE line out and Amp out, even ALL, line or Amp format is selected,	Command: set audout format:amp,line Return: set audio format amp and line for output
26	get hdmi arc mode Variables: <state> = enable disable Default Value: enable	Get hdmi arc mode state for audio output	Command: get hdmi arc mode Return: get hdmi arc mode enable
27	set hdmi arc mode:<state> Variables: <state> = enable disable Default Value: enable	Set hdmi arc mode state for audio output	Command: set hdmi arc mode:disable Return: set hdmi arc mode disable
28	get remote mute mode Variables: <action_mode> = direct inverted direct Default Value: direct	Get remote mute action mode	Command: get remote mute mode Return: get remote mute action mode direct
29	set remote mute mode:<action_mode> Variables: <action_mode> = direct inverted direct Default Value: direct	Set remote mute action mode	Command: set remote mute mode:inverted direct Return: set remote mute action mode inverted direct

Video and Audio Commands (Direct Control)

No.	Command	Function Description	Example
30	get audin mic mix Variables: <ratio>= 0 ~ 100 Default Value: 50	Get microphone audio in mix ratio	Command: get audin mic mix Return: get microphone audio mix ratio 60
31	set audin mic mix:<ratio> Variables: <ratio>= 0 ~ 100 Default Value: 50	Set microphone audio in mix ratio	Command: set audin mic mix:60 Return: set microphone audio mix ratio 60
32	get audout ducking Variables: <state> = { off low medium high } Default Value: off	Get audio output ducking state	Command: get audout ducking Return: get audio output ducking is off
33	set audout ducking:<state> Variables: <state> = { off low medium high } Default Value: off	Set audio output ducking state	Command: set audout ducking:low Return: set audio output ducking to low
34	get audout mode Variables: <state> = mono stereo Default Value: mono	Get audio output mode state	Command: get audout mode Return: get audio output mode is mono
35	set audout mode:<mode> Variables: <state> = mono stereo Default Value: mono	Set audio output mode	Command: set audout mode:stereo Return: set audio output mode to stereo
36	get audout speaker Variables: <resistance> = 4 8 Ohms Default Value: 8	Get audio output speaker load	Command: get audout speaker Return: get audio output speaker load is 8 Ohms
37	set audout speaker:<resistance> Variables: <resistance> = 4 8 Ohms Default Value: 8	Set audio output speaker load	Command: set audout amp load:4 Return: set audio output speaker load to 4 Ohms

Control Commands (Direct Control)

No.	Command	Function Description	Example
1	<p>get serial cmd format</p> <p>Variables: <format>= ASCII HEX <end_flag>= { none r (for \r, Line Feed) n (for \n, Carriage Return) rn (for \r\n, Line Feed and Carriage Return) } Default Value: format = ASCII End_flag = r</p>	Get serial command format	<p>Command: get serial cmd format</p> <p>Return: get serial command format to be ascii and end with LF</p>
2	<p>set serial cmd format:<format>,<end flag></p> <p>Variables: <format>= ASCII HEX <end_flag>= { none r (for \r, Line Feed) n (for \n, Carriage Return) rn (for \r\n, Line Feed and Carriage Return) } Default Value: format = ASCII End_flag = r</p>	Set serial command format	<p>Command: set serial cmd format:hex,rn</p> <p>Return: set serial command format to be hex and end with LF and CR</p>
3	get serial disp on cmd	Get serial control display on commands	<p>Command: get serial disp on cmd</p> <p>Return: get serial display control on command:POWER ON,delay 100ms,HDMI IN1</p>
4	<p>set serial disp on cmd:<cmd1>,<delay_time>,<cmd2></p> <p>Variables: <cmd1>= { none (for clear saved command) ascii or hex command string } <delay_time>= 0 ~ 2000 ms <cmd2>= { none (for clear saved command) ascii or hex command string } Default Value: cmd1 = none delay_time = 100 cmd2= none</p>	Set serial control display on commands	<p>Command: set serial disp on cmd:33 44 AA BB,100,none</p> <p>Return: set serial display control on command:33 44 AA BB,delay 100ms,none</p>

Control Commands (Direct Control)

No.	Command	Function Description	Example
5	get serial disp off cmd	Get serial control display off commands	Command: get serial disp off cmd Return: get serial display control off command:POWER OFF, delay 100ms, none
6	set serial disp off cmd:<cmd1>,<delay_time>,<cmd2> Variables: <cmd1>= { none (for clear saved command) ascii or hex command string } <delay_time>= 0 ~ 2000 ms <cmd2>= { none (for clear saved command) ascii or hex command string } Default Value: cmd1 = none delay_time = 100 cmd2= none	Set serial control display off commands	Command: set serial disp off cmd:33 44 AA BB,1000,55 66 CC DD Return: set serial display control off command:33 44 AA BB,delay 1000ms,55 66 CC DD
7	get serial disp off delay Variables: <time>= 0 ~ 60 s Default Value: 0 s	Get serial control display off delay time	Command: get serial disp off delay Return: get serial control display off delay 30s
8	set serial disp off delay:<time> Variables: <time>= 0 ~ 60 s Default Value: 0 s	Set serial control display off delay time	Command: set serial disp off delay:60 Return: set serial control display off delay 60s
9	set serial disp manual:<state> Variables: <state>= on off	Set serial control display manual on or off	Command: set serial disp manual:on Return: set serial control display manual on
10	send serial cmd:<cmd> Variables: <cmd>= ascii or hex command string	Send serial command out over serial port NOTE: the sent out command string will not be saved in device	Command: send serial cmd:Standby Return: sent serial command:Standby

Control Commands (Direct Control)

No.	Command	Function Description	Example
11	<p>get ir disp on cmd</p> <p>Variables: <cmd_content>= { none (for clear saved command) IR HEX Code }</p>	Get ir control display on command	<p>Command: get ir disp on cmd</p> <p>Return: get ir display control on command:0000 006c 0022 0002 0156 00ac 0015 0015 0016 0015 0016 0015 0015 0015 0016 0040 0015 0015 0016 0040 0015 0015 0016 0040 0015 0040 0016 0040 0016 0040 0015 0015 0016 0040 0015 0015 0016 0040 0015 0040 0016 0040 0016 0040 0015 0015 0016 0040 0015 0015 0016 0015 0016 0015 0015 0015 0016 0015 0016 0015 0015 0040 0016 0015 0015 0040 0016 0040 0016 0040 0015 05f1 0156 0055 0016 0e4f</p>
12	<p>set ir disp on cmd:<cmd_content></p> <p>Variables: <cmd_content>= { none (for clear saved command) IR HEX Code }</p> <p>Default Value: cmd_content = none</p>	Set ir control display on command	<p>Command: set serial disp on cmd:0000 006c 0022 0002 0156 00ac 0015 0015 0016 0015 0016 0015 0015 0015 0016 0040 0015 0015 0016 0040 0015 0015 0016 0040 0015 0040 0016 0040 0016 0040 0015 0015 0016 0040 0015 0015 0016 0040 0015 0040 0016 0040 0016 0040 0015 0015 0016 0040 0015 0015 0016 0015 0016 0015 0015 0015 0016 0015 0016 0015 0015 0040 0016 0015 0015 0040 0016 0040 0016 0040 0015 05f1 0156 0055 0016 0e4f</p> <p>Return: set ir display control on command:0000 006c 0022 0002 0156 00ac 0015 0015 0016 0015 0016 0015 0015 0015 0016 0040 0015 0015 0016 0040 0015 0015 0016 0040 0015 0040 0016 0040 0016 0040 0015 0015 0016 0040 0015 0015 0016 0040 0015 0040 0016 0040 0016 0040 0015 0015 0016 0040 0015 0015 0016 0015 0016 0015 0015 0015 0016 0015 0016 0015 0015 0040 0016 0015 0015 0040 0016 0040 0016 0040 0015 05f1 0156 0055 0016 0e4f</p>
13	<p>get ir disp off cmd</p> <p>Variables: <cmd_content>= { none (for clear saved command) IR HEX Code }</p>	Get ir control display off command	<p>Command: get ir disp off cmd</p> <p>Return: get ir display control off command:0000 006c 0022 0002 0156 00ac 0015 0015 0016 0015 0016 0015 0015 0015 0016 0040 0015 0015 0016 0040 0015 0015 0016 0040 0015 0040 0016 0040 0016 0040 0015 0015 0016 0040 0015 0015 0016 0040 0015 0040 0016 0040 0016 0040 0015 0015 0016 0040 0015 0015 0016 0015 0016 0015 0015 0015 0016 0015 0016 0015 0015 0040 0016 0015 0015 0040 0016 0040 0016 0040 0015 05f1 0156 0055 0016 0e4f</p>
14	<p>set ir disp off cmd:<cmd_content></p> <p>Variables: <cmd_content>= { none (for clear saved command) IR HEX Code }</p> <p>Default Value: cmd_content = none</p>	Set ir control display off command	<p>Command: set ir disp off cmd:0000 006c 0022 0002 0156 00ac 0015 0015 0016 0015 0016 0015 0015 0015 0016 0040 0015 0015 0016 0040 0015 0015 0016 0040 0015 0040 0016 0040 0016 0040 0015 0015 0016 0040 0015 0015 0016 0040 0015 0040 0016 0040 0016 0040 0015 0015 0016 0040 0015 0015 0016 0015 0016 0015 0015 0015 0016 0015 0016 0015 0015 0040 0016 0015 0015 0040 0016 0040 0016 0040 0015 05f1 0156 0055 0016 0e4f</p> <p>Return: set ir display control on command:0000 006c 0022 0002 0156 00ac 0015 0015 0016 0015 0016 0015 0015 0015 0016 0040 0015 0015 0016 0040 0015 0015 0016 0040 0015 0040 0016 0040 0016 0040 0015 0015 0016 0040 0015 0015 0016 0040 0015 0040 0016 0040 0016 0040 0015 0015 0016 0040 0015 0015 0016 0015 0016 0015 0015 0015 0016 0015 0016 0015 0015 0040 0016 0015 0015 0040 0016 0040 0016 0040 0015 05f1 0156 0055 0016 0e4f</p>

Control Commands (Direct Control)

No.	Command	Function Description	Example
22	set relay normal state:<relay_state> Variables: <relay_state>= { open closed } Default Value: open	Set relay normal state	Command: set relay normal state:closed Return: set relay 1 and relay 2 normal state closed
23	get relay momentary time Variables: <time>= 0 ~ 120 s Default Value: 0 s	Get relay momentary time	Command: get relay momentary time Return: get relay momentary time 10s
24	set relay momentary time:<time> Variables: <time>= 0 ~ 120 s Default Value: 0 s	Set relay momentary time	Command: set relay momentary time:20 Return: set relay momentary time 20s
25	get relay disp port	Get relay port for screen up and down control	Command: get relay disp port Return: get relay 1 for screen down, relay 2 for screen up
26	set relay disp port:<screen_up_down> Variables: <screen_up_down> = { 12, (screen up controlled by relay1, screen down controlled by relay2) 21, (screen up controlled by relay2, screen down controlled by relay1) } Default Value: 21	Set relay port for screen up and down control	Command: set relay disp port:12 Return: set relay 1 for screen up, relay 2 for screen down
27	get relay disp off delay Variables: <time>= 0 ~ 300 s Default Value: 30 s	Get relay control display off delay time	Command: get relay disp off delay Return: get relay control display off delay 30s

Control Commands (Direct Control)

No.	Command	Function Description	Example
28	set relay disp off delay:<time> Variables: <time>= 0 ~ 300 s Default Value: 30 s	Set relay control display off delay time	Command: set relay disp off delay:60 Return: set relay control display off delay 60s
29	set relay disp manual:<state> Variables: <state>= on off	set relay control display manual on/off	Command: set relay disp manual:on Return: set relay control display manual on
30	get vidout cec power Variables: <state>= { on, off, varmup, cooldown }	Get current power status from the sink via CEC	Command: get vidout cec power Possible response message include: • get cec on for sink on output • get cec fail for sink on output • No attached sink
31	set vidout cec power Variables: <state>= { on, off }	Set power status on/off for the sink device via CEC	Command: set vidout cec power:on Possible response message include: • set cec on for sink on output • No attached sink
32	set vidout cec standby	Set power standby for the sink device via CEC	Command: set vidout cec standby Possible response message include: • set power standby for sink on output • No attached sink
33	set vidout cec makeactive	Make active for the sink device via CEC	Command: set vidout cec makeactive Possible response message include: • make active for sink on output • No attached sink
34	get vidout cec sleep timeout Variables: <time>= 0 ~ 60 s Default Value: 0 s	Get cec control display off delay time	Command: get vidout cec sleep timeout Return: get cec sleep timeout 30s
35	set vidout cec sleep timeout:<time> Variables: <time>= 0 ~ 60 s Default Value: 0 s	Set cec control display off delay time	Command: set vidout cec sleep timeout:60 Return: set cec sleep timeout 60s
36	set vidout cec disp manual:<state> Variables: <state>= on off	Set cec control display manual on/off	Command: set vidout cec disp manual:on Return: set vidout cec control display manual on
37	get display Variables: <state>= on off	get the last time control state of display on/off	Command: set disp manual:on Return: get display manual on

Control Commands (Direct Control)

No.	Command	Function Description	Example
38	set display:<state> Variables: <state>= on off	set display on/off	Command: set disp manual:on Return: set display manual on
39	get auto display Variables: <state>= enable disable Default Value: enable	get auto display control state	Command: get auto display Return: get auto display enable
40	set auto display:<state> Variables: <state>= enable disable Default Value: enable	set auto display control state	Command: set auto display:disable Return: set auto display disable
41	get auto disp off delay Variables: <time>= 0 ~ 7200 s Default Value: 300 s	Get auto control display off delay time	Command: get auto disp off delay Return: get auto control display off delay 30s
42	set auto disp off delay:<time> Variables: <time>= 0 ~ 7200 s Default Value: 300 s	Set auto control display off delay time	Command: set auto disp off delay:60 Return: set auto control display off delay 60s

Schedule Commands (Direct Control)

No.	Command	Function Description	Example
1	<p>get time</p> <p>Variables: <hour> = 0~23 <minute> = 0~59 <second> = 0~59</p> <p>Default Value: hour = 0 minute = 0 second = 0</p>	Get the current time in Device	<p>Command: get time</p> <p>Return: get the current time is 11:30:40</p>
2	<p>set time:<hour>,<minute>,<second></p> <p>Variables: <hour> = 0~23 <minute> = 0~59 <second> = 0~59</p> <p>Default Value: hour = 0 minute = 0 second = 0</p>	Set the current time in Device	<p>Command: set time:20,30,00</p> <p>Return: set the current time to 20:30:00</p>
3	<p>set date</p> <p>Variables: <day> = 1~31 <month> = 1~12 <year> = xxxx (four digital)</p> <p>Default Value: day = 1 month = 8 year = 2021</p>	Get the current date in Device	<p>Command: get date</p> <p>Return: get the current date is August 1,2021</p>
4	<p>set date: <day>,<month>,<year></p> <p>Variables: <day> = 1~31 <month> = 1~12 <year> = xxxx (four digital)</p> <p>Default Value: day = 1 month = 8 year = 2021</p>	Set the current date in Device	<p>Command: set date:1,9,2021</p> <p>Return: set the current date to September 1,2021</p>
5	<p>get schedule:<event#></p>	Get schedule actions for specified event	<p>Command: get schedule:1</p> <p>Return: get schedule: event:1 action: display on start time:08:00 repeat pattern:by weekly in Monday,Tuesday,Wednesday,Thursday,Friday repeat start:April 11 2021 repeat end:after 100 occurrences action name:display on</p>

No.	Command	Function Description	Example
6	<pre>set schedule:<event#>, <action>,<start_time>, <repeat_pattern>,<repeat_ start>, <repeat_end>, <action_name> Variables: <event#> = 1 ~10 (maximum 10 events) <action> = (can be one or more of below settings) { auto switch enable disable (= set auto switch mode:<state>) switch hdmi1 hdmi2 usbc (= set switch CI) video mute: on off (= set vidout mute) display on off (= set djsplay:<state>) system on off (= system <on off>) volume:0-24 (= set audout volume:<output_volume>) audio mute: on off (= set audout mute:<state>) mic gain:0-8 (= set audin mic gain:<input gain>) } <start_time> = time:hhmm (hh=00~23 Hours, mm=00~59Mins) <repeat_pattern> = { daily (by Daily) week:xxxxxx (by Weekly in selected week days, x=1 0,1=selected, 0=unselected, first digital is Sunday) } <repeat_start> =start:mmddyy (mm=01~12(Month), dd=01~31(Day), yy=01~99(Year)) <repeat_end> = { no end (No End Date) end after:xxx (End after xxx Occurrences xxx<255) end:mmddyy (End by mmddyy, mm=01-12(Month), dd=01-31(Day), yy=01~99(Year)) } <action_name> = name:xxxxxxxxxx (12 digital String(default =NULL) Default Value: " " (blank for no default schedule event)</pre>	Set schedule actions for specified event	<p>Command: set schedule:2,system on,audio mute off,time:1800,week:01111110 start:110421,end:110821,name:system on</p> <p>Return: set schedule: event:2 action:system on,audio mute off start time:18:00 repeat pattern:by weekly in Monday,Tuesday, Wednesday,Thursday,Friday repeat start:April 11 2021 repeat end:end by August 11.2021 action name: system on</p>
7	<pre>remove schedule:<event#> Variables: <event#> = 1 ~10</pre>	remove specified schedule event	<p>Command: remove schedule:1</p> <p>Return: removed schedule event 1</p>

